

DIMASPORT

TRACK & FIELD

Official Supplier
of **ATHLÉ**
French Athletics Federation



WWW.DIMASPORT.FR

CONTENTS

	STARTING-BLOCKS - P4 STOPWATCHES - P4 START - P4 HURDLES - P5
◆ RUNNING	
	POLE VAULT - P6 to 9 HIGH JUMP - P10 to 12 LONG JUMP - P13
◆ JUMPING	
	POLE VAULT SHEDS - P14 HIGH JUMP SHEDS - P15
◆ SHEDS	
	THROWING CAGES - P16 THROWING IMPLEMENTS - P17 THROWING ACCESSORIES - P18
◆ THROWING	
	START/FINISH - P19 STADIUM MATERIAL - P19 MEASURING DEVICES - P19
◆ STADIUM ENVIRONMENT	
	PLYOMETRIC AND AGILITY - P20 TRAINING/DRILLS KITS AND EQUIPMENTS - P21 STORAGE EQUIPMENT - P21 STRENGTH EQUIPMENT - P22
◆ GENERAL	
◆ PHYSICAL PREPARATION	
	PACKS / STADIUM KITS - P24 ANIM'ATHLE AND BABY ATHLE - P25
◆ ATHLETICS GAMES	
	OUTDOOR STADIUM EQUIPMENT - P26 INDOOR STADIUM EQUIPMENT - P27
◆ THE STADIUM	
◆ MADE TO MEASURE	- P28
◆ ABOUT DIMA	- P30
◆ INDEX	- P31
◆ THE DIMA BAG	- P32

Dimasport equips the largest sporting events and meetings with its IAAF-compliant equipment and its certified top-level competition products.

World Athletics (formerly IAAF) certified items can easily be identified by the  and their references are marked in blue [Ref.13288](#).



Tested by a laboratory, all our landing systems are NF-EN 12503-2 type 11 certified, in accordance with the federal competition rules.

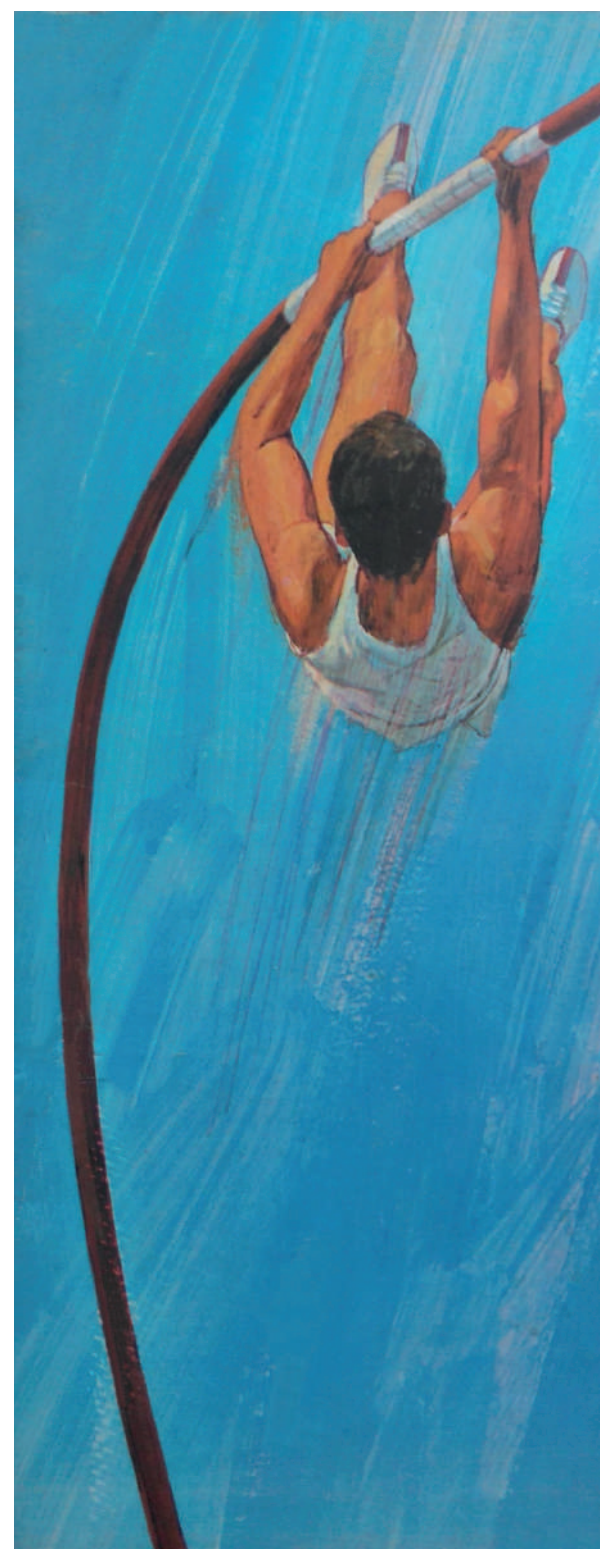

This year
the 50th anniversary of
catalogue and
to the 1972
year of the

DIMA WEBSITE

FIND ALL PRODUCT DETAILS, PRICES, PLANS AND CERTIFICATIONS ON DIMASPORT.FR

Look for a product with its name or reference

The screenshot shows the DIMASPORT website interface. At the top, there's a navigation bar with the DIMASPORT logo and contact information: 'Un fabricant au service des collectivités, des particuliers et des professionnels.' and '01.64.40.05.70'. Below the navigation bar, there's a search bar with a magnifying glass icon. The main content area displays a product page for 'MATELAS PERCHE INTERNATIONAL MODULAIRE 8.00 X 6.00 X 0.87/0.47 M'. The product image shows a blue and red mat with a pole. The price is listed as '15 480,00 € TTC'. There are buttons for 'AJOUTER AU PANIER' and 'AJOUTER AU DEVIS'. To the right of the product, there are links for 'FICHE PRODUIT (AVEC PRIX)', 'FICHE PRODUIT (SANS PRIX)', 'CERTIFICATION', 'DIMENSIONS HORS TOUT PRODUIT', and 'PLAN DE MONTAGE'. Below the product, there are sections for 'PRODUITS SIMILAIRES' and 'PRODUITS COMPLÉMENTAIRES'.

Consult our item descriptions, photos, zooms as well as our prices

Place an order or ask for a quotation in a few clicks

View or download our plans, certifications and other useful documents

A DEDICATED CUSTOMER SERVICE

CONTACTING US IS VERY EASY :

+33 1 64 40 05 70

1 bis rue Louis Armand BP 91

+33 1 64 40 00 37

77834 Ozoir-La-Ferrière cedex

info@dimasport.fr

www.dimasport.fr

we celebrate
the first Track and Field
pay tribute
front cover,
Munich Olympis.

DIMA
Official Supplier
of **ATHLÈ**
French Athletics Federation

DIMASPORT

14, rue du Groupe Manouchian
Paris 20^e ☎ 797 51-75

MUNICH



Diffusion Matériel Sportif
Aniel
raux

STARTING-BLOCKS



Rubber starting block - Per pair
Ref.10112

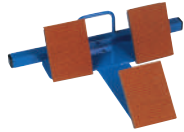

Tripod starting block
Ref.10117

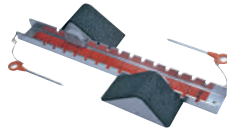

Schools starting blocks
Ref.10113



Physical education starting blocks
Ref.10120



Training starting blocks
Ref.10116



Competition/Club starting block
Ref.10114



Competition starting blocks -
Wide pedals Ref.10102



Elite competition starting blocks
Ref.10100



Bag for starting blocks
Ref.10101

STARTING-BLOCKS CARTS



Carrying cart for 8 starting
blocks on the flat Ref.10105



Compact starting blocks cart
for 8 starting blocks Ref.10104

POWER SLEDS



Power sled
Ref. 70015 - Power sled
Réf. 70009 - Traction belt
with strap and carabiner



Special start power sled
Ref.70016



Power sled
Réf. FIT01730 - Power sled Premium
Réf. FIT01735 - Power sled classic

STOPWATCHES



Case of 24 digi DT1 stopwatches
Ref.15525



Basic stopwatch
Ref.15534



Multi-functional stopwatch
Ref.15521



Coach stopwatch
Ref.15532



Trainer stopwatch
Ref.15522



Major stadium stopwatch
Ref.15523



Pro solar stopwatch
Ref.15529



DT 2000 Stopwatch
Ref.15531



Printer for DT 2000 stopwatch
Ref.15526



Data-transfer software to PC for
DT2000 stopwatch
Ref.15526010



Paper roll for printer for
DT 2000 stopwatch
Set of 10 - Ref.15526020



Digi DT 2500 P stopwatch with
integrated printer Ref.15528



S23571 Seiko stopwatch with
integrated printer Ref.15527



Wireless sprint timing system
Ref.15524

START



Lane marker box - Per unit
Ref.10160



Steel starter's rostrum
Ref.10920



Wooden starter's rostrum
Ref.10922



Aluminum relay batons
Set of 4 Ref.10180



Plastic relay baton
Set of 6 Ref.10181



Start clapper board
Ref.10500



Megaphone range 100m
Ref.10600



Megaphone range 1000m
Ref.10601

● COMPETITION HURDLES



Electro-galvanized international hurdle Ref.10260



Painted international hurdle Ref.10240



Painted aluminum international hurdle Ref.10270



World championship aluminum prestige hurdle Ref.10290



European championship aluminum prestige hurdle Ref.10291



Electro-galvanized automatic international hurdle Ref.10261

*Replacement PVC hurdle board for club/international hurdle Ref.10310

*Customized PVC hurdle board for international hurdle Ref.10312

*Prestige PVC replacement hurdle board for aluminum hurdle Ref.10707

*PVC customized crossbar for aluminum hurdle Ref.10706

● TRAINING HURDLES



Electro-galvanized club hurdle Ref.10300



Special educational club hurdle Set of 5 - Ref.10301

● HURDLE CARTS



Cart for 8 international hurdles Ref.10296



Cart for 8 prestige/international aluminium hurdles Ref.10295



Weather cover for 8 hurdle cart Ref.10298



Hurdle cart for 30 hurdles Ref.10701



Vehicle towing bracket for hurdle cart Ref.10700001



Cart for 60 competition hurdles Ref.10710

● SHED FOR HURDLE CARTS 3.70x3.30x1.70m



Shed on swiveling wheels for 2 hurdle carts Ref.15550

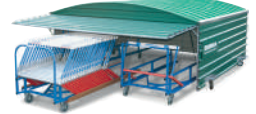

Shed on swiveling wheels for 3 hurdle carts Ref.15560

● INITIATION/TRAINING HURDLES

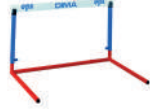

School hurdle Set of 3 Ref.10330 Set of 6 Ref.10336

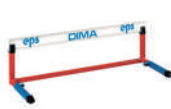

School mini-hurdle Set of 3 Ref.10230 Set of 6 Ref.10236



Replacement hurdle board for school hurdle Ref.10380



Rubber support for school hurdle board Per unit Ref.10320011



20 School hurdle cart Ref.10020



30 School hurdle cart Ref.10021



Mini obstacles 50x12x12cm Ref.10345



Mini obstacles 50x18x18cm yellow Ref.10346



Adjustable GPP foam hurdle Set of 5 Ref.10339



Cross-braced hurdles Height 22 to 106cm Set of 6 Ref.10239



Dimakid hurdles - Set of 6 Height 20cm Ref.10350 Height 40cm Ref.10355 Height mixed (20 et 40cm) Ref.10360



Baby hurdle Set of 3 Ref.10235 Set of 6 Ref.10238 Board Set of 5 Ref.10235002



Foldable PVC training hurdles - Set of 10 Height 20cm Ref.10323 Height 30cm Ref.10324 Height 40cm Ref.10325 Height 50cm Ref.10326



Aluminium auto return hurdles Set of 3 Ref.10210



PVC training hurdle adjustable Set of 3 (Height 40 to 60cm) Ref.10331 Set of 3 (Height 55 to 95cm) Ref.10337 Set of 6 (Height 40 to 60cm) Ref.10332



GPP hurdles adjustable - Set of 3 Height 20-30cm Ref.10333 Height 40-60cm Ref.10334



Foldable hurdles adjustable height 30 or 50cm Set of 6 Ref.10234



Step hurdles Set of 6 (Height 15cm) Ref.10232 Set of 6 (Height 30cm) Ref.10233



Step hurdle carry strap Ref.10237



Foam hurdle L100cm x H40cm Ref.10340

● STEEPLE CHASE BARRIERS



* Steeplechase barrier 4 m Ref.10951



* Steeplechase barrier 5 m Ref.10953



Mini steeplechase barrier (76-91cm) Ref.10979



* Steeplechase water jump barrier with surface mount Ref.10944



* Steeplechase water jump barrier with ground sleeves Ref.10943



Steeplechase water jump cover Ref.10945



Replacement wooden beam 3.66m Ref.10955001



Replacement wooden beam 4m Ref.10956001



Replacement wooden beam 5m Ref.10958001

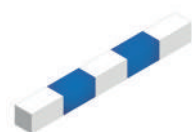

Replacement wooden beam for mini steeplechase barrier Ref.10959



Steeplechase barrier transportation cart Ref.10957



Cart for steeplechase barrier Per pair Ref.10954



JUMPING



● BASIC POLE VAULT LANDING SYSTEM 4.25X5X0.60/0.40M



Basic pole vault landing system
Ref.17250



Weather cover
Ref.17251

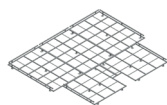

Galvanized platform
Height 10cm
Ref.14045

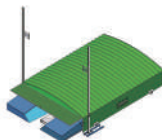

Standard Shed
Fixed wheels Ref.15510F
Swivelling wheels Ref.15510

● CLUB POLE VAULT LANDING SYSTEM 6.30X5M



Club modular pole vault landing system
6.30x5.00x0.80/0.50m
Ref.19160

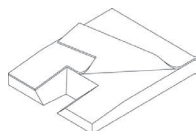

Club comfort plus single cover landing system
6.30x5.00x0.80/0.50m
Ref.19165

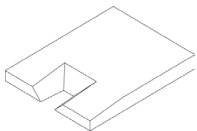

Club single cover pole vault landing system
6.30x5.00x0.73/0.43m
Ref.19166



Weather cover
Ref.19161 Height 0.80m
Ref.19167 Height 0.73m

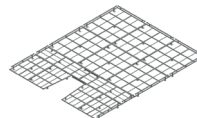

Galvanized platform
Height 10cm
Ref.14081

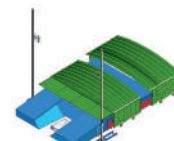

Standard Shed
Fixed wheels Ref.15506F
Swivelling wheels Ref.15506



Integral shed
Fixed wheels Ref.15506FI
Swivelling wheels Ref.15506I

● MEETING POLE VAULT LANDING SYSTEM 7X5X0.80/0.50M



Meeting modular
Ref.13800



Meeting comfort plus single cover
Ref.13804



Meeting single cover
Ref.13802



Weather cover
Ref.13805

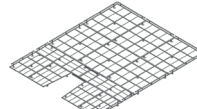

Galvanized platform
Height 10cm
Ref.13806

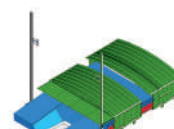

Standard Shed
Fixed wheels Ref.15600F
Swivelling wheels Ref.15600

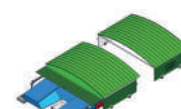

Integral shed
Fixed wheels Ref.15600FI
Swivelling wheels Ref.15600I

● REVERSIBLE POLE VAULT LANDING SYSTEM ON PLATFORM 7X5X0.80/0.50M



Reversible meeting modular with platform
Ref.13835



Weather cover
Ref.13836

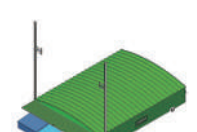

Standard Shed
Fixed wheels Ref.15514F
Swivelling wheels Ref.15514

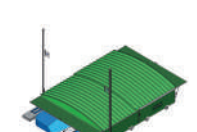

Integral shed
Fixed wheels Ref.15514FI
Swivelling wheels Ref.15514I

● FEDERAL POLE VAULT LANDING SYSTEM 7.50X5.50X0.80/0.50M



Federal modular
Ref.14066

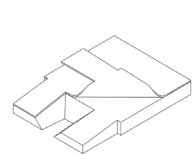

Federal comfort plus single cover
Ref.14068

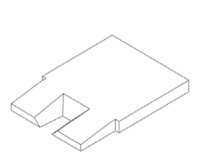

Federal single cover
Ref.14069



Weather cover
Ref.14061

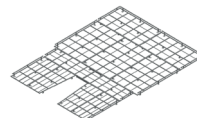

Galvanized platform
Height 10cm
Ref.14072

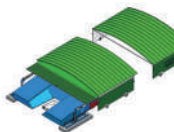

Integral shed
Fixed wheels Ref.15517FI
Swivelling wheels Ref.15517I

● INTERNATIONAL POLE VAULT LANDING SYSTEM 8X6X0.80/0.50M



International modular
Ref.13712

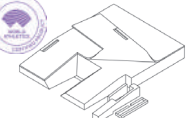

International comfort plus single cover
Ref.13717

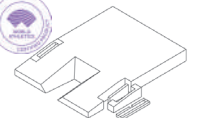

International single cover
Ref.13713



Weather cover
Ref.13714

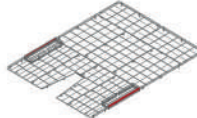

Galvanized platform
Height 10cm
Ref.14070

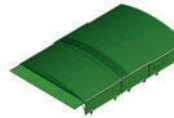

Integral shed
Fixed wheels Ref.15618FI
Swivelling wheels Ref.15618I

● CONCEPT IV POLE VAULT LANDING SYSTEM 9.50X6.20X0.87/0.37M



Concept IV modular
Ref.13739



Weather cover
Ref.13740

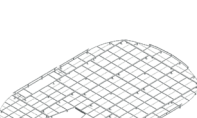

Galvanized platform
Height 10cm
Ref.14055

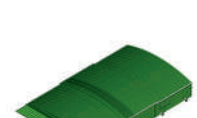

Integral shed
Fixed wheels Ref.15616FI
Swivelling wheels Ref.15616I

World Athletics Level 1
Regional & national level [FFA]

Official Supplier
of **ATHLÉ**
French Athletics Federation

World Athletics Level 1
Regional & national level [FFA]

Official Supplier
of **ATHLÉ**
French Athletics Federation

World Athletics Level 1
Regional & national level [FFA]

Official Supplier
of **ATHLÉ**
French Athletics Federation

World Athletics Level 2
Elite Championship Level [FFA]

Official Supplier
of **ATHLÉ**
French Athletics Federation

World Athletics Level 2
Elite Championship Level [FFA]

Official Supplier
of **ATHLÉ**
French Athletics Federation



● REVERSIBLE POLE VAULT LANDING SYSTEM ON PLATFORM 7X5X0.80/0.50M

World Athletics Level 1
Regional & national level [FFA]

Official Supplier
of **ATHLÉ**
French Athletics Federation



Reversible meeting modular with platform
Ref.13835

Weather cover
Ref.13836

Standard Shed
Fixed wheels Ref.15514F
Swivelling wheels Ref.15514

Integral shed
Fixed wheels Ref.15514FI
Swivelling wheels Ref.15514I

● MEETING DOUBLE FRONT POLE VAULT LANDING SYSTEM 10X5X0.80/0.50M

World Athletics Level 1
Regional & national level [FFA]

Official Supplier
of **ATHLÉ**
French Athletics Federation



Meeting double front modular
Ref.19140

Meeting double front comfort plus single cover
Ref.19142

Meeting double-front single cover
Ref.19143

Weather cover
Ref.19141

Galvanized platform
Height 10cm
Ref.14095

Standard Shed
Fixed wheels Ref.15610F
Swivelling wheels Ref.15610

Integral shed
Fixed wheels Ref.15610FI
Swivelling wheels Ref.15610I

● INTERNATIONAL UP & DOWN DOUBLE FRONT POLE VAULT LANDING SYSTEM 11X6M

World Athletics Level 2
Elite Championship Level [FFA]

Official Supplier
of **ATHLÉ**
French Athletics Federation

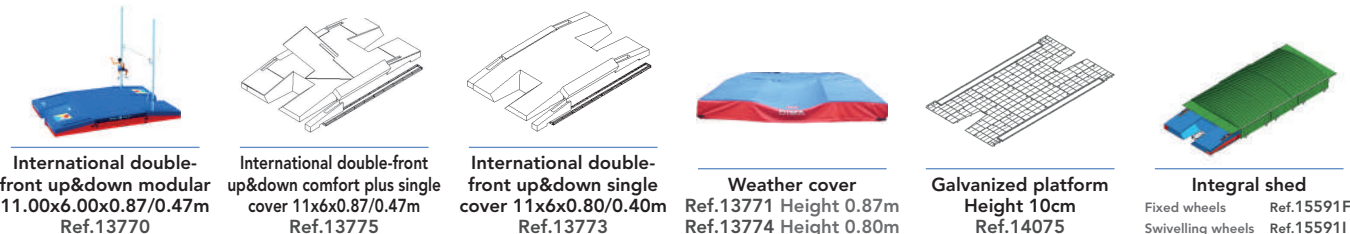

International double-front up&down modular
11.00x6.00x0.87/0.47m
Ref.13770

International double-front up&down comfort plus single cover
11x6x0.87/0.47m
Ref.13775

International double-front up&down single cover
11x6x0.80/0.40m
Ref.13773

Weather cover
Ref.13771 Height 0.87m
Ref.13774 Height 0.80m

Galvanized platform
Height 10cm
Ref.14075

Integral shed
Fixed wheels Ref.15591F
Swivelling wheels Ref.15591I

● RAILS

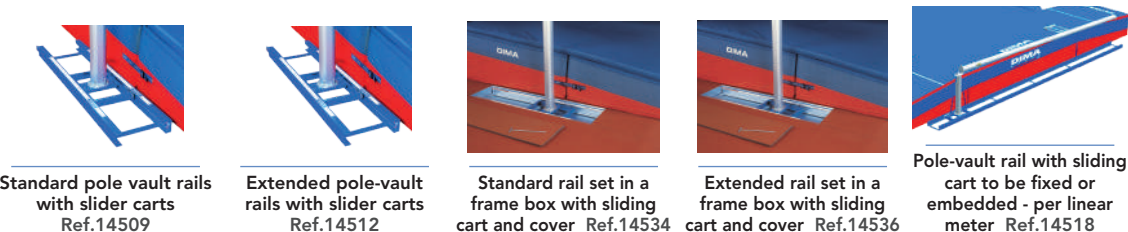

Standard pole vault rails with slider carts
Ref.14509

Extended pole-vault rails with slider carts
Ref.14512

Standard rail set in a frame box with sliding cart and cover
Ref.14534

Extended rail set in a frame box with sliding cart and cover
Ref.14536

Pole-vault rail with sliding cart to be fixed or embedded - per linear meter
Ref.14518

● POLE VAULT STANDARDS

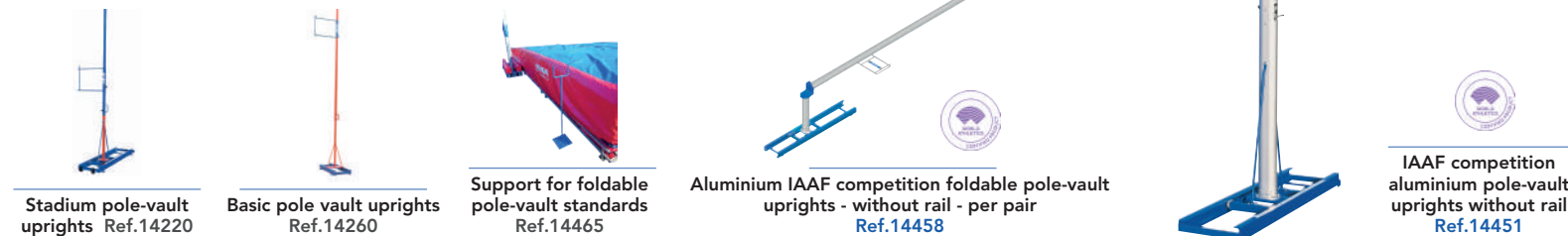

Stadium pole-vault uprights
Ref.14220

Basic pole vault uprights
Ref.14260

Support for foldable pole-vault standards
Ref.14465

Aluminium IAAF competition foldable pole-vault uprights - without rail - per pair
Ref.14458

IAAF competition aluminium pole-vault uprights without rail
Ref.14451

● POLE VAULT PROTECTIONS

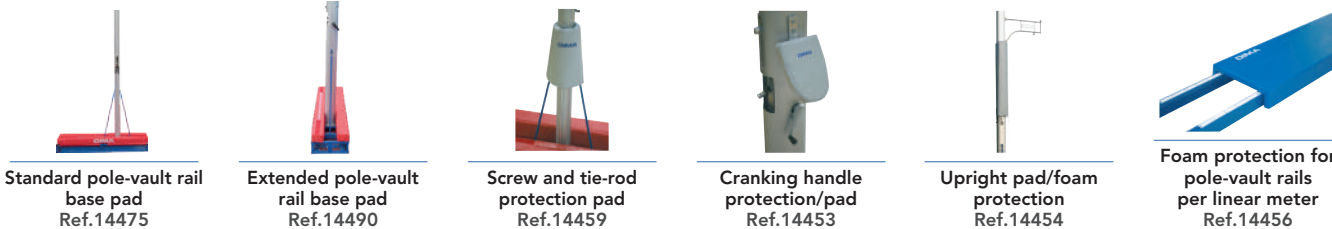

Standard pole-vault rail base pad
Ref.14475

Extended pole-vault rail base pad
Ref.14490

Screw and tie-rod protection pad
Ref.14459

Cranking handle protection pad
Ref.14453

Upright pad/foam protection
Ref.14454

Foam protection for pole-vault rails per linear meter
Ref.14456

● POLE VAULT STANDARDS ACCESSORIES

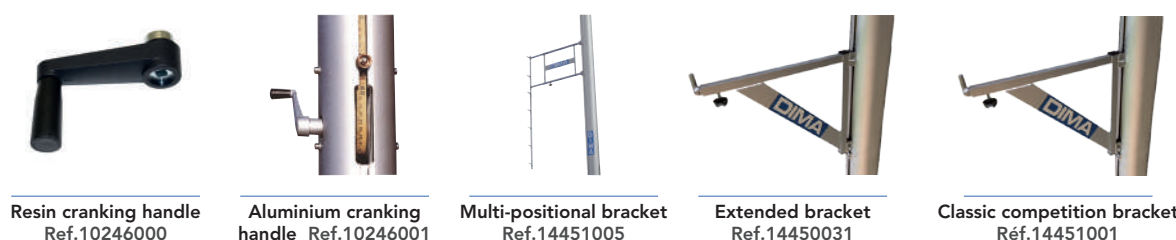

Resin cranking handle
Ref.10246000

Aluminium cranking handle
Ref.10246001

Multi-positional bracket
Ref.14451005

Extended bracket
Ref.14450031

Classic competition bracket
Ref.14451001



JUMPING

VAULT BOX

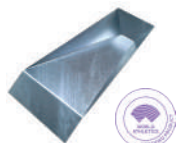

Vault box
Ref.11120

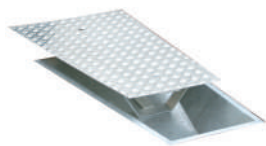

Vault box lid
Réf. 11110 Classic
Réf. 11111 Adjustable and to be surfaced

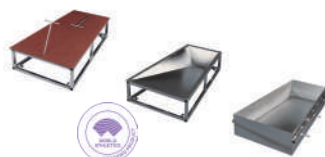

Removable vault box
Complete system Ref.11130



Movable training vault box
Ref.11102



Free standing vault box
Ref.11105

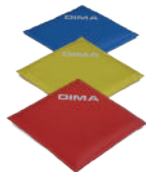

Pole vault mat
Ref.11107



Foam pole support
Ref.11104



Fixed pole rack
Ref.12330



Mobile pole bag rack
Ref.12331

POLE VAULT KIT



Pole vault plus athletics pack
Ref.70130



Crossbar placers - Per pair
Ref.14460
Mini crossbar placers - Per pair
Ref.14470



Pole vault athletics pack
Ref.70140



Basic double front extension
Ref.17230



Pole-vault upright setting
indicator board Ref.10785

More details on
dimasport.fr

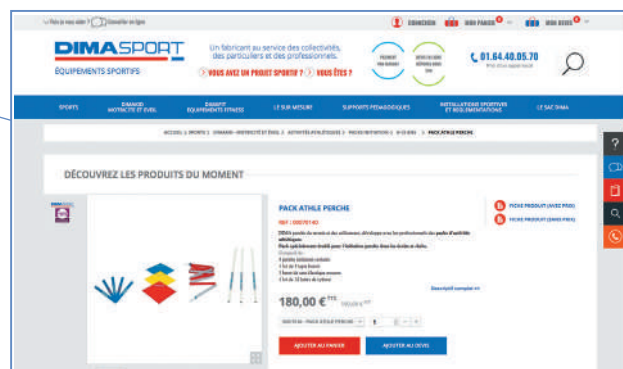

POLE VAULT ACCESSORIES



Foam elastic crossbar
Ref.10570



Elastic tape crossbar
Ref.10580



Elastic roll/bungee cord - 25m
Ref.10560



Competition pole-vault crossbar
4.50m Ref.14410



IAAF certified pole-vault crossbar
4.50m Ref.14411



Competition telescopic height
gauge with pointer
Ref.11582



Rolling rack for crossbars
Ref.14415



Officials' flags red/white
Per pair - Ref.11300



Officials' flags yellow
Per pair - Ref.11310



Take-off markers
Set of 10 Ref.11321



Windsock
Ref.76000003



Basic chalk bowl
Ref.21111



Chalk/magnesia - Set of 8 pains
Ref.21110010



Dima official's clipboard
Ref.10820



Foam drainage dome
Ref.14005



Aluminum drainage dome
Ref.14006



Portable pole rack
Ref.12333



Pole stacking shed
Ref.15530



Swivelling wheels for pole
stacking shed
Ref.15535



POLES



Beginners fiberglass pole 2m
Ref.10080



NEW

Pacer One pole

3M35	Weight	Tip
Ref.19512	36kg (80LBS)	21
Ref.19513	41kg (90LBS)	21
Ref.19514	45kg (100LBS)	21
Ref.19515	50kg (110LBS)	21
3M60		
Ref.19521	41kg (90LBS)	21
Ref.19522	45kg (100LBS)	21
Ref.19523	50kg (110LBS)	21
Ref.19524	54kg (120LBS)	21
Ref.19525	59kg (130LBS)	18
4M		
Ref.19532	50kg (110LBS)	18
Ref.19534	54kg (120LBS)	18
Ref.19536	59kg (130LBS)	18



NEW

Pacer FXV pole

3M50	Weight	Tip
Ref.15025	45kg	21
Ref.15026	54kg	21
Ref.15027	59kg	16
3M75		
Ref.15002	45kg	21
Ref.15003	54kg	18
Ref.15004	63kg	18
4M		
Ref.15030	50kg	18
Ref.15040	54kg	18
Ref.15050	59kg	18
Ref.15060	63kg	18
Ref.15070	68kg	18
4M25		
Ref.15090	57kg	16
Ref.15100	59kg	16
Ref.15110	61kg	13
Ref.15120	63kg	13
Ref.15130	66kg	13
Ref.15140	68kg	13
Ref.15150	70kg	13
Ref.15160	73kg	13
Ref.15161	75kg	13
Ref.15162	77kg	10
Ref.15163	80kg	10
4M40		
Ref.18334	59kg	13
Ref.18336	61kg	13
Ref.18338	63kg	10
Ref.18340	66kg	10
Ref.18342	68kg	10
Ref.18344	70kg	10
Ref.18346	73kg	10
4M60		
Ref.15180	63kg	10
Ref.15190	66kg	10
Ref.15200	68kg	10
Ref.15210	70kg	10
Ref.15220	73kg	7
Ref.15230	75kg	7
Ref.15240	77kg	10
Ref.15250	80kg	7
Ref.15251	82kg	5
Ref.15253	84kg	5



Dima Lancet fiberglass pole

2M70	Weight
Ref.27024	24kg
Ref.27027	27kg
Ref.27030	30kg
Ref.27033	33kg
Ref.27035	35kg
Ref.27037	37kg
Ref.27041	41kg
Ref.27044	44kg

3M10	Weight
Ref.18000	25kg
Ref.18200	27kg
Ref.18010	30kg
Ref.18210	33kg
Ref.18020	35kg
Ref.18220	37kg
Ref.18230	40kg
Ref.18240	43kg
Ref.18250	45kg
Ref.14950001	Dima Lancet pole tip



NEW

Pacer composite pole - Fiberglass

4M15	Poids	Embout
Ref.71501	57kg (125LBS)	18
Ref.71502	59kg (130LBS)	18
Ref.71503	61kg (135LBS)	16
Ref.71504	63kg (140LBS)	16

4M25	Poids	Embout
Ref.71511	59kg (130LBS)	16
Ref.71512	61kg (135LBS)	16
Ref.71513	63kg (140LBS)	16
Ref.71514	66kg (145LBS)	16

4M40	Poids	Embout
Ref.71521	61kg (135LBS)	13
Ref.71522	63kg (140LBS)	13
Ref.71523	66kg (145LBS)	10
Ref.71524	68kg (150LBS)	10

4M60	Poids	Embout
Ref.71600	63kg (140LBS)	13
Ref.71610	66kg (145LBS)	10
Ref.71620	68kg (150LBS)	10
Ref.71630	70kg (155LBS)	10
Ref.71640	73kg (160LBS)	10
Ref.71650	75kg (165LBS)	10
Ref.71660	77kg (170LBS)	10
Ref.71670	80kg (175LBS)	10
Ref.71680	82kg (180LBS)	7
Ref.71690	84kg (185LBS)	7

4M90	Poids	Embout
Ref.70310	73kg (160LBS)	10
Ref.70340	75kg (165LBS)	10
Ref.70370	77kg (170LBS)	10
Ref.70400	80kg (175LBS)	10
Ref.70430	82kg (180LBS)	7
Ref.70450	84kg (185LBS)	7
Ref.70480	86kg (190LBS)	5

5M	Poids	Embout
Ref.71010	77kg (170LBS)	10
Ref.71020	80kg (175LBS)	7
Ref.71070	82kg (180LBS)	7
Ref.71120	84kg (185LBS)	7
Ref.71170	86kg (190LBS)	5
Ref.71171	88kg (195LBS)	5
Ref.71172	91kg (200LBS)	4
Ref.71173	93kg (205LBS)	4
Ref.71174	95kg (210LBS)	4



Pacer pole tip

Référence	Tip
Ref.14932	2
Ref.14934	4
Ref.14935	5
Ref.14937	7
Ref.14940	10
Ref.14943	13
Ref.14946	16
Ref.14948	18
Ref.19600	21



Pole car rack
Ref.15570



Pole bag

Référence	Length
Ref.15458	3.10 / 3.35 m
Ref.15459	3.50 / 3.75 m
Ref.15460	4.00 / 4.25 m
Ref.15470	4.40 / 4.60 m
Ref.15480	4.80 / 5.00 m
Ref.15455	Customised pole bag
Ref.15490	Padlock security for pole bag
Ref.15491	Rigid sheath for pole bag (per linear meter)

● SINGLE COVER HIGH JUMP LANDING SYSTEMS



Single cover high jump landing system

4.50x2.50x0.50m Ref.15980
5x2.50x0.50m Ref.15990
5x3x0.50m Ref.15995



Weather cover

4.50x2.50x0.50m Ref.15841
5x2.50x0.50m Ref.16983
5x3x0.50m Ref.16615

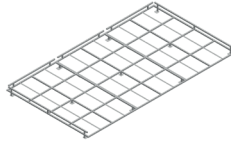

Galvanized platform
Height 10cm

4.50x2.50m Ref.15845
5x2.50m Ref.15812
5x3 m Ref.15847

● AIRFOAM HIGH JUMP LANDING SYSTEM



Airfoam high jump landing system

4x2x0.50m Ref.15760
4.50x2.50x0.50m Ref.15840
5x3x0.50m Ref.19090



Weather cover

4x2x0.50m Ref.15761
4.50x2.50x0.50m Ref.15841
5x3x0.50m Ref.16615

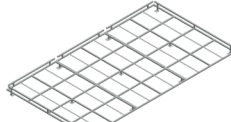

Galvanized platform
Height 10cm

4x2m Ref.15765
4.5x2.5m Ref.15845
5x3m Ref.15847

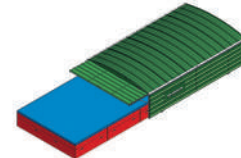

Shed

Fixed wheels Ref.15500F Swivelling wheels Ref.15500
Fixed wheels Ref.15611F Swivelling wheels Ref.15611

● BASIC HIGH JUMP LANDING SYSTEM 5X2.50X0.60M



Basic high jump
Ref.17200



Weather cover
Ref.17201



Galvanized platform
Height 10cm
Ref.15812



Shed

Fixed wheels Ref.15501F
Swivelling wheels Ref.15501

● CLUB FFA HIGH JUMP LANDING SYSTEM 5X3X0.70M



Club FFA modular
Ref.19030

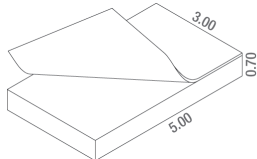

Club FFA Comfort plus
single cover
Ref.19085

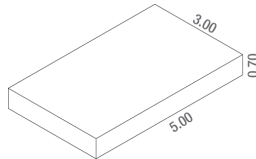

Club FFA single cover
Ref.19083

World Athletics Level 1
Regional level [FFA]



Weather cover
Ref.19031

Official Supplier
of **ATHLÉ**
French Athletics Federation

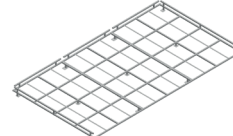

Galvanized platform
Height 10cm
Ref.15847

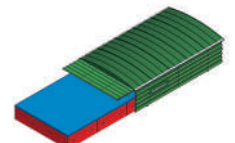

Shed

Fixed wheels Ref.15611F
Swivelling wheels Ref.15611



More details on
dimasport.fr

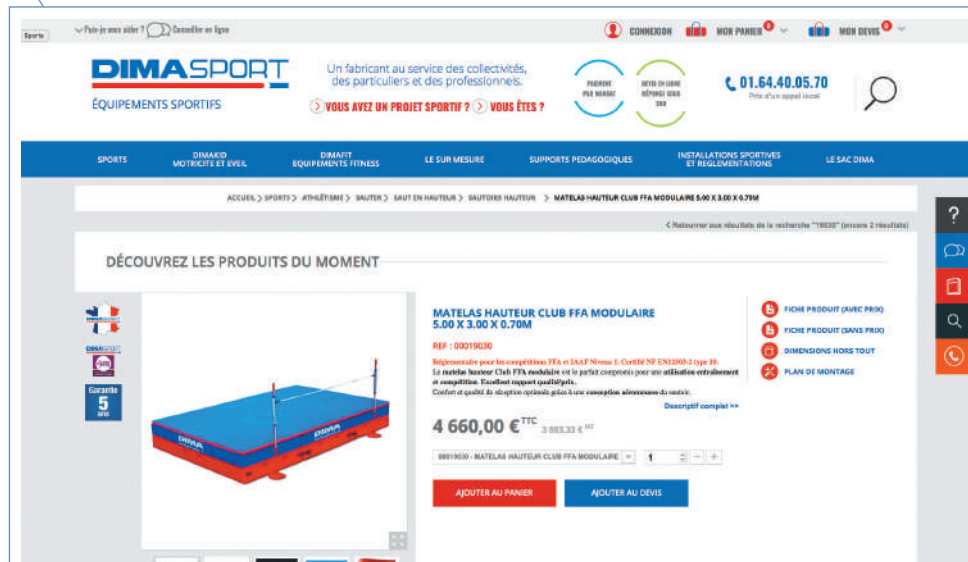

● INTERCLUB HIGH JUMP LANDING SYSTEM 6X3X0.70M

World Athletics Level 1
Regional level [FFA]

Official Supplier
of **ATHLÉ**
French Athletics Federation



Interclub modular
Ref.19060

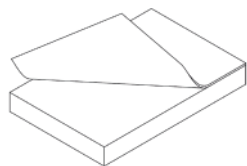

Interclub comfort plus
single cover
Ref.19065

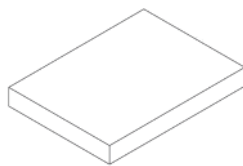

Interclub single
cover
Ref.19063



Weather cover
Ref.19062

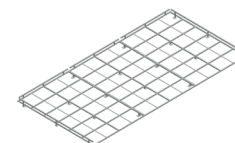

Galvanized platform
Height 10cm
Ref.15848

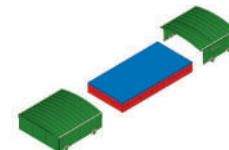

Shed
Fixed wheels Ref.15516F
Swivelling wheels Ref.15516

● CHALLENGER HIGH JUMP LANDING SYSTEM 6X3.25/3X0.70M

World Athletics Level 1
Regional level [FFA]

Official Supplier
of **ATHLÉ**
French Athletics Federation



Challenger modular
Ref.19170

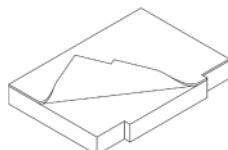

Challenger comfort plus
single cover
Ref.19175

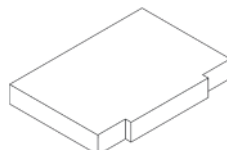

Challenger single
cover
Ref.19173



Weather cover
Ref.19071

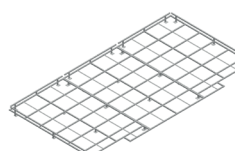

Galvanized platform
Height 10cm
Ref.15830

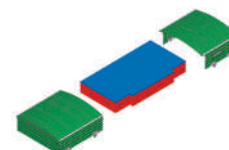

Shed
Fixed wheels Ref.15516F
Swivelling wheels Ref.15516

● INTERNATIONAL HIGH JUMP LANDING SYSTEM 6X4X0.70M

World Athletics Level 2
National & Elite Championship Level [FFA]

Official Supplier
of **ATHLÉ**
French Athletics Federation



International modular
Ref.19045

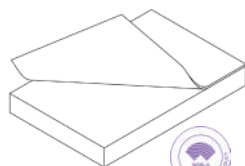

International comfort
plus single cover
Ref.19055

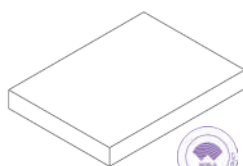

International single
cover
Ref.19042



Weather cover
Ref.19043

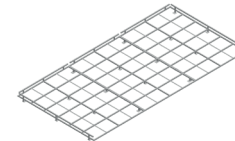

Galvanized platform
Height 10cm
Ref.15821

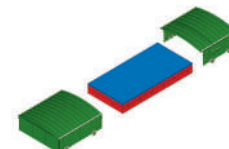

Shed
Fixed wheels Ref.15608F
Swivelling wheels Ref.15608

● CHALLENGER IAAF HIGH JUMP LANDING SYSTEM 6X4.25/4X0.70M

World Athletics Level 2
National & Elite Championship Level [FFA]

Official Supplier
of **ATHLÉ**
French Athletics Federation



IAAF challenger
modular
Ref.19112

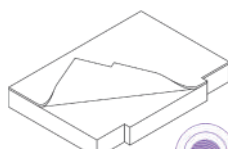

IAAF challenger comfort
plus single cover
Ref.19116



Weather cover
Ref.19113

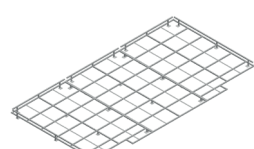

Galvanized platform
Height 10cm
Ref.15815

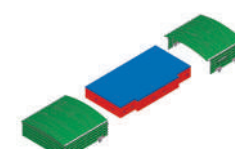

Shed
Fixed wheels Ref.15619F
Swivelling wheels Ref.15619

● GRAND CHAMPIONNAT HIGH JUMP LANDING SYSTEM 7X4.25/4X0.70M

World Athletics Level 2
National & Elite Championship Level [FFA]

Official Supplier
of **ATHLÉ**
French Athletics Federation



Major championship
modular
Ref.15690



Major championship
comfort plus single
cover
Ref.15695



Weather cover
Ref.15691

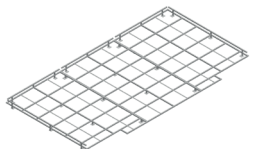

Galvanized platform
Height 10cm
Ref.15755

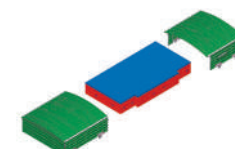

Shed
Fixed wheels Ref.15518F
Swivelling wheels Ref.15518

● CONCEPT III HIGH JUMP LANDING SYSTEM 8X4.25/4X0.70M

World Athletics Level 2
National & Elite Championship Level [FFA]

Official Supplier
of **ATHLÉ**
French Athletics Federation



Concept III modular
Ref.19076



Weather cover
Ref.19077

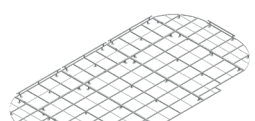

Galvanized platform
Height 10cm
Ref.15832



Shed
Fixed wheels Ref.15519F
Swivelling wheels Ref.15519

• HIGH JUMP STANDARDS



School high jump standards
Ref.14150



Multi-position high jump standards
Ref.14320



Club high jump standards
Ref.14310



Club high jump standards with deflector
Ref.14311



Interclub high jump standards
Ref.14315



Competition telescopic steel high jump standards
Ref.14305



IAAF high jump standards with 2 bar rests
Ref.14300



IAAF high jump standards with 3 bar rests
Ref.14301



Elite telescopic high jump standards
Ref.14306



Super elite aluminum high jump standards with cranking handles
Ref.14307



Grand prix aluminum high jump standards
Ref.14302



Major championship aluminum high jump standards with cranking handle
Ref.14303

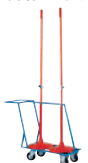

High jump standard cart/trolley
Ref.14312



Step ladder - 2 steps
Ref.10924

• HIGH JUMP ACCESSORIES



Major competition high jump crossbar 4m
Ref.14401



Competition high jump crossbar 4m
Ref.14400



Mini high-jump crossbar placer 110cm
Ref.14480



Foam elastic crossbar
Ref.10570



Elastic roll/bungee cord - 25m
Ref.10560



Foam drainage dome
Ref.14005



Aluminum drainage dome
Ref.14006



Competition telescopic high jump height gauge from 0.85 to 3m
Ref.11581



Aluminium school high jump height gauge marked 2m
Ref.11541



Aluminium height gauge with sliding marker graduated 2,5m
Ref.11560



Elastic tape crossbar
Ref.10580



Rolling Rack For Crossbars
Ref.14415



Drying surface roller
Ref.13170

• MADE TO MEASURE



Replacement cover
Ref.15860



Airfoam replacement units
Per cbm - Ref.80000010



Weather cover
Per sqm - Ref.15862

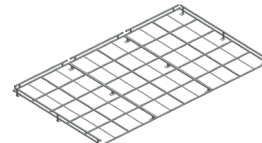

Galvanized platform
Per sqm - Ref.15881

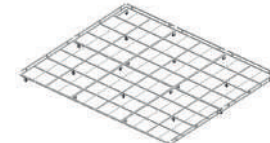

Galvanized platform on castors
Per sqm - Ref.15891



Spike-proof top pad - 7cm thick
Per sqm - Ref.15870



Spike-proof top pad - 10cm thick
Per sqm - Ref.15871



Finish protection pad
Per sqm - Ref.23030001



Customized printing
Ref.70000057



Equipment cart with towing bracket
Ref.10730



Equipment cart with ball-bearing mounted towing bracket
Ref.10720



Horizontal transportation cart 2.50x1.22m
Ref.22351



Locking platform
Ref.15885



Vertical transportation cart
Ref.22352

LONG JUMP





Competition take-off board
Ref.11262



Installation tray for competition take-off board
Ref.11264

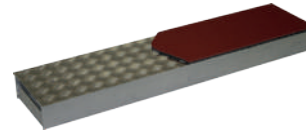

Installation tray for competition take-off board - special renovation
Ref.11266



Blanking lid with edges for competition take-off board
Ref.11272004

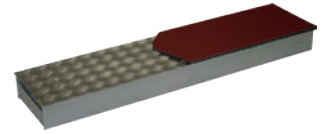

Blanking lid without edges for competition take-off board
Ref.11272002



Foul board for competition take-off board
Ref.11262002



Wooden adaptor for competition take-off board
Ref.11265

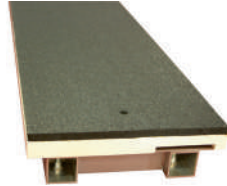

Reversible take-off board
Ref.11250

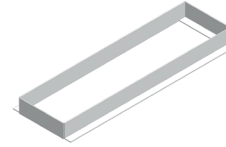

Frame for reversible take-off board
Ref.11261



Foul board for reversible competition take-off board
Ref.11260002



Plasticine spatula
Ref.11285



Plasticine load
Ref.11280

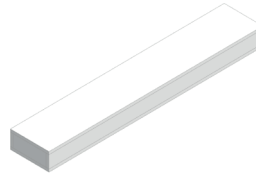

School take-off board
Ref.11240

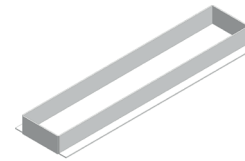

Installation tray for school take-off board
Ref.11241



Foul board cart
Ref.12332



Long jump distance indicator boards (5.6.7.8.9) - Set of 5
Ref.11345



Triple jump distance indicator boards (14.15.16.17.18) - Set of 5
Ref.11365



Long jump PVC distance indicator board
Ref.11340



Triple jump PVC distance indicator board
Ref.11360

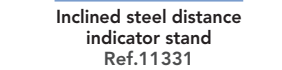

Inclined steel distance indicator stand
Ref.11331



Vertical steel distance indicator stand
Ref.11330



Tape skate kit
Ref.11605



Sand border
Ref.11380

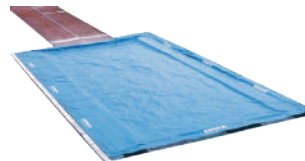

Sand pit cover for long jump and triple jump - Per sqm
Ref.15863 (with eyelets)
Ref.15864 (with ballast bags)
Ref.15865 (with ballast bars)

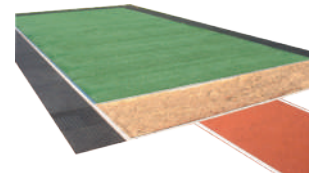

Aluminium sand pit cover for long jump and triple jump
Ref.11370



Take-off board markers
Per pair - Ref.11269



Laser optic measuring device for long jump/triple jump
Ref.11420



Sand pit rake
Ref.76000005



Sand pit scraper
Ref.76000006



Sand pit broom
Ref.76000007



Sand pit shovel
Ref.76000004



Rounded wooden jump training box/GPP step
Ref.10762 120x40x5cm
Ref.10761 120x40x10cm
Ref.10760 120x40x20cm



Standard GPP benches / plyo boxes
Ref.10770 Height 10cm
Ref.10771 Height 20cm
Ref.10772 Height 30cm
Ref.10773 Height 40cm
Ref.10774 Height 50cm
Ref.10775 Synthetic-optional



Stacking plyo boxes
Set of 4 Ref.10777



Trapezoid plyometric boxes / benches
Set of 3 Ref.10750



Rounded steel bench / plyobox
Ref.10765

STANDARD POLE VAULT SHED

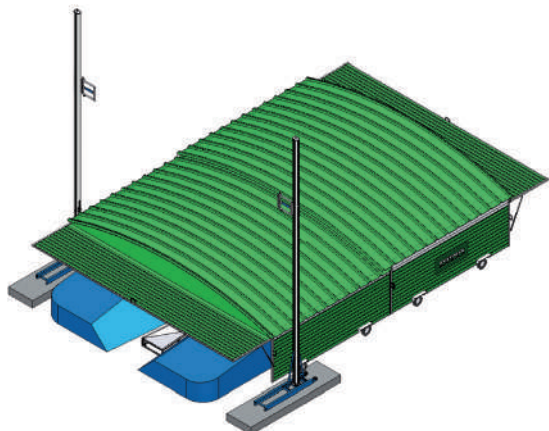

Fixed wheel



Swivelling wheel



Jack-operated

Designation	Landing mat dimensions	Fixed wheels	Swivelling wheels	Characteristics	
Shed for Basic pole vault landing system	5x4.25x0.60m	Ref.15510F	Ref.15510	1 element	1 jack-operated door
Shed for Club pole vault landing system	6.30x5x0.80m	Ref.15506F	Ref.15506	2 elements	1 jack-operated door
Shed for Meeting pole vault landing system	7x5x0.80m	Ref.15600F	Ref.15600	2 elements	1 jack-operated door
Shed for Reversible pole vault landing system	7x5x0.80m	Ref.15514F	Ref.15514	2 elements	2 jack-operated doors
Shed for Federal pole vault landing system	7.50x5.50x0.80m		See Integral Shed		
Shed for International pole vault landing system	8x6x0.87m		See Integral Shed		
Shed for Concept IV pole vault landing system	9.50x6.20x0.87m		See Integral Shed		
Shed for Meeting double front pole vault landing system	10x5x0.80m	Ref.15610F	Ref.15610	3 elements	2 jack-operated doors
Shed for International double front pole vault landing system	11x6x0.87m		See Integral Shed		
Made to measure Shed for pole vault landing system		Ref.15500070	Ref.15500020		

INTEGRAL POLE VAULT SHED

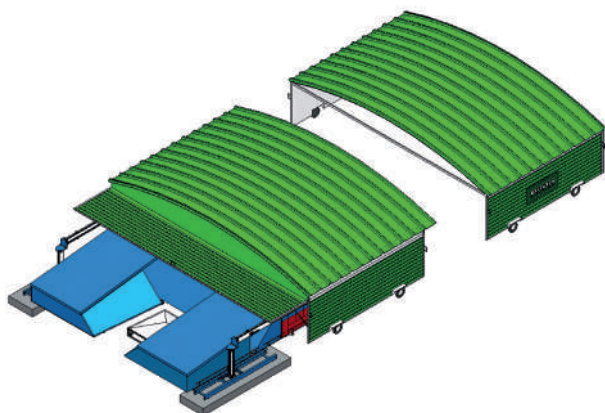

Designation	Landing mat dimensions	Fixed wheels	Swivelling wheels	Characteristics	
Integral Shed for Club pole vault landing system	6.30x5x0.80m	Ref.15506FI	Ref.15506I	2 elements	1 jack-operated door
Integral Shed for Meeting pole vault landing system	7x5x0.80m	Ref.15600FI	Ref.15600I	2 elements	1 jack-operated door
Integral Shed for Reversible pole vault landing system	7x5x0.80m	Ref.15514FI	Ref.15514I	2 elements	2 jack-operated doors
Integral Shed for Federal pole vault landing system	7.50x5.50x0.80m	Ref.15517FI	Ref.15517I	2 elements	1 jack-operated door
Integral Shed for International pole vault landing system	8x6x0.87m	Ref.15618FI	Ref.15618I	2 elements	1 jack-operated door
Integral Shed for Concept IV pole vault landing system	9.50x6.20x0.87m	Ref.15616FI	Ref.15616I	3 elements	1 jack-operated door
Integral Shed for Meeting double front pole vault landing system	10x5x0.80m	Ref.15610FI	Ref.15610I	3 elements	2 jack-operated doors
Integral Shed for International double front pole vault landing system	11x6x0.87m	Ref.15591FI	Ref.15591I	3 elements	2 jack-operated doors
Made to measure integral Shed for pole vault landing system		Ref.15500070	Ref.15500020		

● STANDARD HIGH JUMP SHED



Designation	Landing mat dimensions	Fixed wheels	Swivelling wheels	Characteristics
Shed for EPS high jump landing system	4x2.50x0.50m	Ref.15500F	Ref.15500	1 element
Shed for Basic high jump landing system	5x2.50x0.60m	Ref.15501F	Ref.15501	1 element
Shed for Club high jump landing system	5x3x0.70m	Ref.15611F	Ref.15611	1 element
Shed for Interclub high jump landing system	6x3x0.70m	Ref.15516F	Ref.15516	2 elements
Shed for Challenger high jump landing system	6x3.25/3x0.70 m	Ref.15516F	Ref.15516	2 elements
Shed for International high jump landing system	6x4x0.70m	Ref.15608F	Ref.15608	2 elements
Shed for Challenger IAAF high jump landing system	6x4.25/4x0.70m	Ref.15619F	Ref.15619	2 elements
Shed for Grand Championnat high jump landing system	7x4.25/4x0.70m	Ref.15518F	Ref.15518	2 elements
Shed for Concept III high jump landing system	8x4.25/4x0.77m	Ref.15519F	Ref.15519	2 elements
Made to measure Integral Shed for high jump landing system		Ref.15500060	Ref.15500010	

● POLE STACKING SHED



Swivelling wheels for pole stacking shed Ref.15535

Pole stacking shed Ref.15530



Shed on swivelling wheels for 2 hurdle carts Ref.15550



Shed on swivelling wheels for 3 hurdle carts Ref.15560



Equipment shed with swivelling wheels
5.10x2.35x1.90 m
Ref.15520

Equipment shed for fixed ground installation
5.00x2.00x1.70 m
Ref.15540

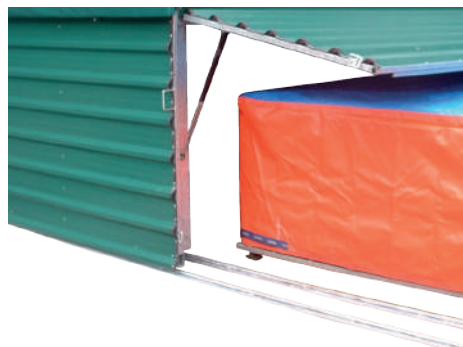

Shed on rail -> On request

THROWING

HAMMER THROWING CAGE

FFA and IAAF compliant



IAAF galvanized steel hammer cage with ground sleeves Ref.13278

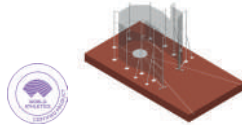

IAAF aluminum hammer cage with galvanized steel doors and ground sleeves Ref.13293

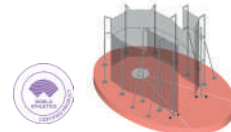

IAAF aluminum hammer cage with ground sleeves Ref.13289



Rolling strips for I.A.A.F. panels - the pair Ref.13340

Galvanized steel hammer cage with foldable brackets (upon request)



Reinforced shot/hammer circle with cross bracing Ref.11160



Shot/hammer circle with cross bracing Ref.11161



Hammer conversion circle Ref.11190

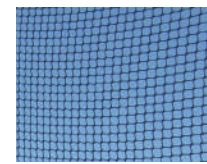

Net
 Net for hammer cage 24.50 x 7.30 m
 Exterior net for hammer cage 25.5 x 7.30m
 Net for hammer cage exit lane and doors 10.30x5.80m
 Custom-made 5mm polypropylene net - per sqm
 Custom-made 4mm polypropylene net - per sqm

Ref.30714001
 Ref.3072822
 Ref.30714007
 Ref.30714006
 Ref.30714005

DISCUS THROWING CAGE

FFA and IAAF compliant

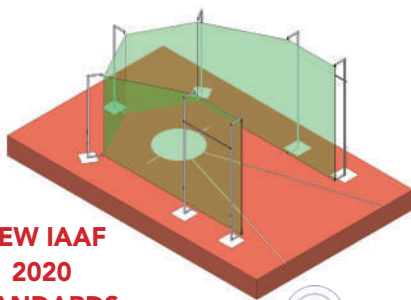

NEW IAAF
 2020
 STANDARDS

IAAF galvanized steel discus cage with ground sleeves Ref.13278

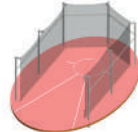

Aluminium discus cage 4.50 m high (above ground) Ref.13271



Portable galvanized steel discus cage Ref.13277

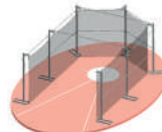

Portable aluminum discus cage Ref.13270



Discus circle with cross bracing Ref.11200



Anti-rebound safety net with supports Ref.13360



Discus circle with cross bracing Ref.11201



Portable discus throwing circle 40mm thick Ref.11400000

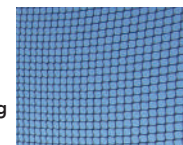

Net
 Net for discus cage 24.4 x 4.5 m - 6.4 m
 Net for discus cage 26 x 5 meters
 Custom-made 5mm polypropylene Net - per sqm
 Custom-made 4mm polypropylene Net - per sqm

Ref.30714018
 Ref.30714000
 Ref.30714006
 Ref.30714005

INDOOR SHOT PUT THROWING CAGE

FFA and IAAF compliant

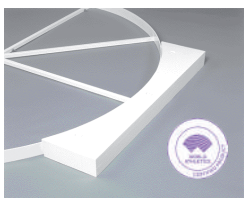

IAAF synthetic shot toeboard Ref.11222



Lacquered pine shot toeboard Ref.11220



Aluminum shot toeboard 80 mm Ref.11221



Shot/hammer circle with cross bracing Ref.11161



Reinforced shot/hammer circle with cross bracing Ref.11160



Surround protection structure with net for shot area - per lm Ref.11400003



Indoor shot put throwing cage dimensions: 15x10x15m - height: 4 meters
 15x10x15m Ref. 11400015
 20x10x20m Ref. 11400020



Foam protection pad for indoor shot put throwing cage - per linear meter Ref.11400010



Portable shot put throwing platform with integrated toeboard
 Height 70mm Ref. 11400001
 Height 40mm Ref. 11400005



Portable shot put throwing platform with integrated toeboard
 Height 70mm Ref. 11400070
 Height 40mm Ref. 11400004



Indoor shot put throwing landing system - 42mm thick
 Per sqm - Ref.11400002



Shot put throwing landing system 100mm thick
 Per sqm - Ref.11400006



Portable shot put throwing circle with integrated toeboard 40mm thick Ref.11400007



Handisport thrower seat Ref.13200

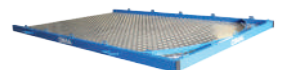

Throwing platform for handisport seat Ref.13210

HAMMERS



Cast iron hammer

Ref.12915 2kg Ref.12920 3kg
Ref.12930 4kg Ref.12940 5kg
Ref.12950 6kg Ref.12960 7.26kg



Steel hammer

Ref.12979 2kg Ref.12980 3kg
Ref.12990 4kg Ref.13000 5kg
Ref.13035 6kg Ref.13020 7.26kg



Steel hammer

Ref.13044 4KG-095mm Ref.13041 4KG-100mm
Ref.13046 5kg-100mm Ref.13047 6kg-105mm
Ref.13040 7.26kg-110mm Ref.13042 7.26kg-113mm
Ref.13043 7.26kg-115mm



Brass-plated steel hammer

Ref.13052 4kg-95mm
Ref.13054 7.26kg-110mm



Steel training hammer

Ref.13098 8kg Ref.13099 9kg
Ref.13100 10kg



Hammer case

Ref.13095



Hammer glove

Ref.13048 left hand S Ref.13049 left hand M
Ref.13050 left hand L Ref.13056 right hand S
Ref.13055 right hand M Ref.13051 right hand L



Hammer training replacement handle

Ref.13060 Training
Ref.13080 Competition



Spare hammer cable

Ref.13090 For men 100cm
Ref.13091 For women 98cm



Training throwing weights/hammer

Ref.13101 5.45kg Ref.13102 7.26kg
Ref.13103 9.08kg Ref.13104 11.34kg
Ref.13105 15.88kg



Mobile hammer rack

Ref.12212



Rolling circular rack for hammers

Ref.12210



Rubber hammer

Ref.13151 350g Ref.13154 500gr
Ref.13150 1kg Ref.13152 1.5kg
Ref.13153 2kg



Medicine ball with handle

Ref.21354 1kg Ref.21364 2kg
Ref.21366 3kg Ref.21374 4kg



Heavy throwing weight

Ref.13106 On demand

DISCUS



Rubber discus

Ref.12340 600gr Ref.12341 800gr
Ref.12350 1kg Ref.12351 1.25kg
Ref.12360 1.5kg Ref.12370 1.75kg
Ref.12380 2kg



Soft discus

Ref.12384 Set of 3 - 200gr
Ref.12383 Set of 3 - 300gr
Ref.12385 Set of 3 - 500gr



PVC multi throw discus with handle

Ref.12386 400gr
Ref.12387 600gr
Ref.12388 800gr



Rubber rings

Ref.75110 Set of 6



Throwing ring

Ref.75121 Set of 3 - 400gr
Ref.75131 Set of 3 - 600gr



Plastic challenger discus

Ref.12000 600gr Ref.12020 800gr
Ref.12030 1kg Ref.12040 1.25kg
Ref.12050 1.5kg Ref.12060 1.75kg
Ref.12080 2kg



Interclub wooden discus

Ref.12300 600gr Ref.12301 800gr
Ref.12302 1kg Ref.12303 1.25kg
Ref.12304 1.5kg Ref.12305 1.75kg
Ref.12306 2kg



Discus

Ref.12480 600gr Ref.12481 800gr
Ref.12520 1kg Ref.12251 1.25kg
Ref.12530 1.5kg Ref.12540 1.75kg
Ref.12550 2kg



Obol african competition discus

Ref.12521 800gr Ref.12522 1kg
Ref.12523 1.25kg Ref.12524 1.5kg
Ref.12525 1.75kg Ref.12526 2kg



Obol plastic competition discus

Ref.12473 800gr Ref.12474 1kg
Ref.12475 1.25kg Ref.12476 1.5kg
Ref.12477 1.75kg Ref.12478 2kg



Obol mahogany competition discus

Ref.12561 800gr Ref.12560 1kg
Ref.12571 1.25kg Ref.12570 1.5kg
Ref.12580 1.75kg Ref.12590 2kg



Black super spin discus

Ref.12145 1kg Ref.12146 1.5kg
Ref.12147 2kg



Red super spin II discus

Ref.12205 1kg
Ref.12206 : 2kg



Gold super spin discus

Ref.12140 1kg Ref.12141 1.5kg
Ref.12142 1.75kg Ref.12143 2kg



Yellow super spin discus

Ref.12148 1kg Ref.12150 1.5kg
Ref.12151 1.75kg Ref.12152 2kg



Discus bag

Ref.12215



Mobile discus rack

Ref.12213

SHOT PUT



Indoor rubber shot

Ref.12779 2kg Ref.12789 3kg
Ref.12799 4kg Ref.12809 5kg
Ref.12819 6kg Ref.12829 7.26kg



Soft rubber shots for schools

Ref.12904 1kg diam100mm Ref.12905 1.5kg diam100mm
Ref.12906 2kg diam120mm Ref.12907 3kg diam125mm
Ref.12908 4kg diam135mm Ref.12909 5kg diam135mm
Ref.12910 6kg diam140mm Ref.12911 7.26kg diam 140mm



Weighted ball

Ref.12840 200gr Ref.12850 500gr
Ref.12860 1kg Ref.12870 1.5kg
Ref.12880 2kg Ref.12890 3kg



Cast iron shots

Ref.12601 Set of 3-2kg Ref.12611 Set of 3-3kg
Ref.12621 Set of 3-4kg Ref.12631 Set of 3-5kg
Ref.12641 Set of 3-6kg Ref.12651 Set of 3-7.26kg
Ref.12670 2kg Ref.12670 2kg Ref.12670 2kg
Ref.12700 5kg Ref.12700 5kg Ref.12700 5kg
Ref.12680 3kg Ref.12690 4kg
Ref.12710 6kg Ref.12720 7.26kg



Steel shot

Ref.12680 3kg Ref.12690 4kg
Ref.12710 6kg Ref.12720 7.26kg



Steel shot

Ref.12741 4kg diam95mm Ref.12752 5kg diam115mm
Ref.12742 4kg diam100mm Ref.12753 6kg diam115mm
Ref.12744 4kg diam105mm Ref.12754 6kg diam120mm
Ref.12750 4kg diam108mm Ref.12762 7.26kg diam113mm
Ref.12751 5kg diam110mm Ref.12761 7.26kg diam115mm
Ref.12763 7.26kg diam120mm
Ref.12764 7.26kg diam125mm
Ref.12770 7.26kg diam128mm



Brass-plated steel shot

Ref.12772 4kg diam95mm
Ref.12774 7.26kg diam115mm



Mobile shot rack

Ref.12221



Shot case

Ref.12230



Shot put channel

Ref.12225

THROWING

JAVELIN



Turbo javelin
Ref.11720



Rocket javelin
Ref.11726 Set of 3-33cm/125gr
Ref.11724 Set of 6-33cm/125gr



Foam javelin
Ref.11723 : 90cm/50gr



Comet ball
Ref.11715 6 thrower + 6 ball
Ref.11716 Set of 6 ball
Ref.11717 Set of 6 thrower



Knocken ball
Ref.11730 : 200gr Ref.11731 : 400gr
Ref.11732 : 600gr Ref.11733 : 800gr



Beginners javelin with plastic tip
Ref.14152 Set of 3 300gr
Ref.14154 Set of 3 400gr
Ref.14155 Set of 3 500gr
Ref.14156 Set of 3 600gr



Aluminium schools javelin
Ref.11675 Set of 3 300gr
Ref.11691 Set of 3 400gr
Ref.11651 Set of 3 500gr
Ref.11661 Set of 3 600gr
Ref.11671 Set of 3 700gr
Ref.11681 Set of 3 800gr



Club steel javelin
Ref.11851 Set of 3 400gr
Ref.11852 Set of 3 500gr
Ref.11853 Set of 3 600gr
Ref.11854 Set of 3 700gr
Ref.11855 Set of 3 800gr



Two-colored competition javelin
Ref.11740 400gr
Ref.11750 500gr
Ref.11760 600gr
Ref.11770 700gr
Ref.11780 800gr



Javelin/poles carrying tube
Ref.12241



Super obol competition javelin
Ref.11960 600gr
Ref.11970 700gr
Ref.11980 800gr



Competition javelin
Ref.11751 500gr
Ref.11761 600gr
Ref.11771 700gr
Ref.11781 800gr



Nemeth universal javelin
Ref.82400 400gr
Ref.82500 500gr
Ref.82600 600gr
Ref.82700 700gr
Ref.82800 800gr



Nemeth club javelin
Ref.82205 600gr 70m
Ref.82206 600gr 75m
Ref.82207 800gr 80m
Ref.82208 800gr 90m



Nemeth classic javelin
Ref.82201 600gr 75m
Ref.82202 600gr 80m
Ref.82203 800gr 85m
Ref.82204 800gr 90m



Nordic javelin

Ref.82200 600gr - Viking 50 m - Flex 11.1
Ref.82150 600gr - Diana NXB 50 m - Flex 7.7
Ref.82050 600gr - Master alu - Flex 7.9
Ref.82100 600gr - Diana NXB 60 m - Flex 7.2
Ref.82000 600gr - Diana acier - Flex 6.2
Ref.80100 800gr - Master 70 m - Flex 7.5
Ref.80201 800gr - Superelite NXS 80 m - Flex 7.0
Ref.80000 800gr - Orbit acier - Flex 6.6
Ref.80050 800gr - Champion acier - Flex 6.4
Ref.80200 800gr - Airglider acier - Flex 6.1



Javelin display rack
Ref.12240



Round javelin rack
Ref.12242



Javelin carrying case
Ref.12010

THROWING ACCESSORIES



Long throwing distance marker box
Ref.11000



Short throwing distance marker box
Ref.10980



Long throwing distance field markers
Set of 12 Ref.10460



Short throwing distance field markers
Set of 12 Ref.10440



Sector flags
Per pair Ref.11050



Implement certification kit
Ref.11611



Electronic weighing scale for athletics throwing devices
Ref.11631



Sector line cart
Ref.11040



Plastic sector line
Ref.11020



Fixing staples
Set of 100 Ref.11030



Officials' flags red/white
Per pair Ref.11300



Officials' flags yellow
Per pair Ref.11310



Basic chalk bowl
Ref.21111



Chalk/magnesia
Set of 8 Ref.21110010



Metric tape
Ref.10390 20m
Ref.10395 50m



Multi-purpose carrying cart
Ref.10107



Target hoops
Set of 3 Ref.10190



Club athletics beginners pack - throwing
Ref.70116



Athletics discovery pack - throwing
Ref.70113



Throwing area
Ref.11108



Baby athle target
150x170cm
Ref.70095



Target for throwing event landing area
- 300X100cm
Ref.70097



Vertical target for throwing
130x130cm
Ref.70098



Target area
130x130cm
Ref.70099

STADIUM ENVIRONMENT

START/FINISH



Lane marker box
Per unit Ref.10160



Wooden starter's rostrum
Ref.10922



Steel starter's rostrum
Ref.10920



Start clapper board
Ref.10500



Megaphone range
Ref.10601 Range 1000m
Ref.10600 Range 100m



Hand whistle
Ref.10511



Whistle with lanyard
Ref.10510 Set of 3



Relay batons
Ref.10180 Set of 4 aluminium
Ref.10181 Set of 6 plastic



Timing platform with camera stand
Ref.10690 With camera stand
Ref.10691 Clear weather cover - optional



Timers and judges stand
Eef.10680 8 steps



Timers and judges stand
Ref.10602 8 seats
Ref.10622 16 seats



Finish posts to be cast in concrete
Ref.10860 Per pair



Lap counter with bell on heavy base
Ref.10840 on heavy base
Ref.10841 to be cast in concrete



3 place awards stand/stacking plinths
Ref.10883



3 place steel award's stand
Ref.10881



3 place wooden award's stand
Ref.10880



3 place extended wooden award's stand
Ref.10882



Finish protection pad
Ref.23030001 Per sqm

STADIUM EQUIPMENT



Dima official's clipboard
Ref.10820



Free lane 10cm cone markers
Ref.10170 Set of 7



Windsock
Ref.76000003



Free lane flag
Ref.11050010



Take-off markers
Ref.11321 Set of 10 multicolors



Section banners
Ref.90000 50m



Banner fixing post
Ref.90001 Set of 10



Post for section banner
Ref.14360



Drying surface roller
Ref.13170



Chalk/magnesia
Ref.21111
Ref.21110010
Set of 8 Chalk/ magnesia blocks



Step ladder - 2 steps
Ref.10924



Mat winder with mandrel
Ref.13190



Training synthetic track roll
6mm - black
Ref.13172 Roll of 10mx1.25
Ref.13173 Per linear meter



Training synthetic track roll
12mm - black
Ref.13162 Roll of 10mx1.25
Ref.13163 Per linear meter



Mondo competition synthetic track 12mm - Red
Ref.13161 Roll of 15mx1.22
Ref.13160 Per linear meter



Transport trolley for a synthetic roll
Ref.00013195



Grass track line marker
Ref.11010 Grass track line marker
Ref.11010001 Paint

MEASURES



Fiberglass measuring tape
Ref.11500 10m measuring tape
Ref.11510 20m measuring tape
Ref.11520 30m measuring tape
Ref.11522 50m with handle
Ref.11525 100m with handle



Steel measuring tape
Ref.11430 10m measuring tape
Ref.11440 20m measuring tape
Ref.11450 30m measuring tape
Ref.11470 30m with handle
Ref.11480 50m with handle
Ref.11490 100m with handle



Distance measuring wheel
Ref.11640



Pedometer
Ref.11641



Compact wind gauge
Ref.11626



Ultrasonic wind gauge
Ref.11620



Laser distance measuring system
Ref.11615



Laser optic measuring device for long jump/triple jump
Ref.11420



Electronic countdown timer
Ref.11610



Wind speed indicator cart
Ref.10784 Cart with seat



Performance indicator cart
Ref.10782 Cart with seat
Ref.10781 Cart (without seat)



Pole-vault upright setting indicator board
Ref.10785



Portable raised running track unit width 1.22m
Ref.13420 Running track unit 2.50m with synthetic surfacing
Ref.13421 Running track unit 2.50m with synthetic surfacing and vault box
Ref.13422 Running track unit 2.50m with synthetic surfacing and take-off board

GENERAL PHYSICAL PREPARATION

● PLYOMETRIC AND AGILITY



Training synthetic track roll 6mm - black
Ref.10372 Set of 20 straight lines



Foot speed ladder
Ref.10377

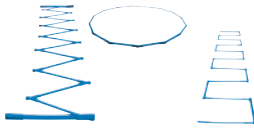

Agility ladder
Ref.10381



Agility hoop ladder
Ref.K5206

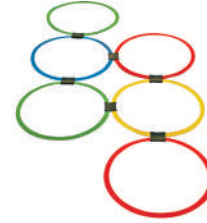

Hoops ladder
Ref.K5205



Foldable variable height step hurdles 15 & 30cm
Ref.10234 Set of 4 with bag (Height 15/30 cm)



Flat cone marker
Ref.10495 diam 20cm height 5cm/ Set of 20
Ref.10496 diam 20cm height 5cm/ Set of 40
Ref.10497 diam 30cm height 20cm/Set of 20



Cone markers carry strap
Ref.10498



Multi-functional flat cone hurdles
Ref.10403 Set of 10 haut 15cm
Ref.10404 Set of 10 haut 20cm



Multi-functional cone hurdles
Ref.10415 Set of 3 (height-7-20-32cm)
Ref.10416 Set of 3 (height-9-24-39cm)

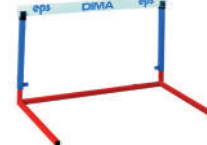

School hurdle adjustable height
Ref.10330 Set of 3 hurdles
Ref.10336 Set of 6 hurdles

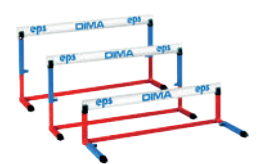

School mini-hurdle
Ref.10230
Set of 3 mini hurdles



GPP hurdles
Ref.10333 Set of 3 (haut 20-30cm)
Ref.10334 Set of 3 (haut 40-60cm)



PVC training hurdle
Ref.10331 Set of 3 (adjustable de 40 to 60cm)
Ref.10337 Set of 3 (adjustable de 40 to 95cm)
Ref.10332 Set of 6 (adjustable de 40 to 60 cm)



Aluminium auto return hurdles
Ref.10210 Set of 3



Individual training mat
Ref.23951
100x50x3cm - 50x50x6



Foam folding hurdle mat
Ref.23936 Set of 4 Height 35cm (unfolded 100x70cm)
Ref.23941 Set of 4 Height 50cm (unfolded 100x100cm)
Ref.23946 Set of 4 Height 65cm (unfolded 100x130cm)

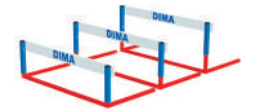

Baby hurdle
Ref.10235 Set of 3
Ref.10238 Set of 6

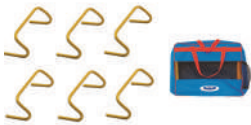

Step hurdles
Ref.10232 Set of 6 Height 15cm
Ref.102233 Set of 6 Height 30 cm



Mini obstacles
Ref.10345 Set of 8 (50x12x12cm)
Ref.10346 Set of 8 (50x18x18cm)



Adjustable GPP foam hurdle
Ref.10339 Set of 5



Dimakid hurdles
Ref.10350 Set of 6 (Height 20cm)
Ref.10355 Set of 6 (Height 40cm)
Ref.10360 Set of 6 (Mixed set)



Foam hurdle L100cm x H40cm
Ref.10340



Stacking plyo boxes
Ref.10777 Set of 4



Cross mat
Ref.23940 150x150x1.5cm



Skipping roper
Ref.10370 in PVC with handle length 280cm
Ref.10369 in cotton without handle length 305cm



Foam plyometric box
Ref.70038 120x120x60cm



Foam Plyo boxes
Ref. FIT01720 60cm Ref. FIT01721 50cm
Ref. FIT01722 30cm Ref. FIT01723 15cm
Ref. FIT01724 Set of 4 plyo boxes



Standard GPP benches / plyo boxes
Ref.10770 Height 10cm
Ref.10771 Height 20cm
Ref.10772 Height 30cm
Ref.10773 Height 40cm
Ref.10774 Height 50cm
Ref.10775 Synthetic-optional



Trapezoid plyometric boxes / benches
Ref.10750 Set of 3 (Height 20-30-40cm)



Rounded steel bench / plyobox
Ref.10765 120x75x20cm



Rounded wooden jump training box/GPP step
Ref.10762 Height 5cm
Ref.10761 Height 10cm
Ref.10760 Height 20cm



Adjustable plyo bench adjustable every 10 cm from 35 to 115 cm
Ref.FIT01725



Stacking plinths
Ref.10883 3 elements



Exercise / Yoga mat
Ref.14945 Set of 10 (140x60x0.80cm)
Ref.14950 Set of 10 (180x60x0.80cm)
Ref.14951 Mobile rack (80x60x200cm)
Ref.14952 Wall support



Wooden gymnastic bench
Ref.Banc2 2m
Ref.Banc3 3m
Ref.Banc4 4m



End-assembling gymnastics track
Ref.22360 600x100x5.5cm



Fully assembling gymnastics school mat
Ref.23590 200x100x4cm

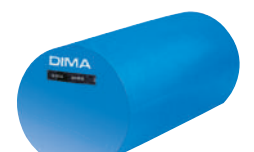

Extra large cylinder foam module diameter 80cm - length 100cm
Ref.14330

GENERAL PHYSICAL PREPARATION

• TRAINING/DRILLS KITS AND EQUIPMENTS



Multi-purpose holed marker cones with slotted top
 Ref.K5010 Set of 4 Height 37 cm
 Ref.K5015 Set of 4 Height 50cm



PVC cone markers
 Ref.10485 Set of 12 cones Height 17cm
 Ref.10490 Set of 12 cones Height 37cm



Cones numbered 5 to 40 Ref.10486
 Set of 8 Height 30cm



Soft rubber cone markers 18cm
 Ref.10480 Set of 12 Height 18cm



Mobility course equipment
 Ref.K5070



Multi-purpose Bricks
 Ref.K5045 Set of 12 bricks
 Ref.K5051 Set of 12 bricks top



Set of game markers
 Ref.K5090 :
 20 straight lines
 + 12 arrows
 + 4 corners + 12 curves



Set of markers
 Ref.K5085 :
 10 round shapes,
 10 square shapes,
 10 triangle shapes



Set of 10 hands + 10 feet floor markers
 Ref.K5095



Vinyl tape
 Ref.10373 10m
 Ref.10374 20m



Multi-activity pack
 Ref.10406 1 pack
 Ref.10407 4 packs with bag



Nylon pinnies
 Ref.HOCK650 (6 yellows + 6 red)
 Ref.HOCK651 (6 blue + 6 green)



Flag football/rugby belt
 Ref.K5056
 Set of 5 belt



Flat hoops
 Ref.K5020 diam 35cm per unit
 Ref.K5022 diam 50cm per unit
 Ref.K5025 diam 60cm per unit
 Ref.K5026 diam 70cm per unit

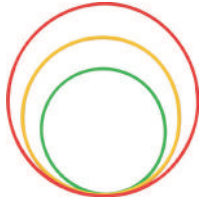

Hula hoops
 Ref.10196 diam 50cm per unit
 Ref.10197 diam 75cm per unit



Bag for hoops
 Ref.SC67 for hoops of diam 35-50cm
 Ref.SC68 for hoops of diam 60-70 cm

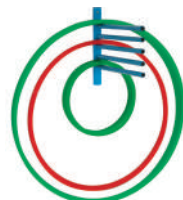

Hoop wall bracket
 Ref.10198



Rotating clips
 Ref.K5040 Rotating clips for 25mm diameter poles + flat hoops
 Ref.K5041 Rotating clips for 25mm diameter poles + hoops
 Ref.K5042 Rotating clips for 25mm diameter pole + pole

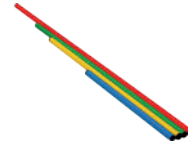

Pole diameter 25mm
 Ref.K5029 Set of 8 pole 60 cm
 Ref.K5030 Set of 8 pole 100 cm
 Ref.K5035 Set of 8 pole 120 cm
 Ref.K5036 Set of 8 pole 160 cm



Plastic base to be filled
 Ref.10195 Per pair



Rounder base
 Ref.10192 Per pair



Multi-purpose base
 Ref.10191



Target hoops
 Ref.10190
 Set of 3



Multi-discovery kit
 Ref.K5075



Multi-function hurdles
 Ref.10400 Set of 5 with bag



Slalom poles with plastic spikes
 Ref.K5037 Set of 12 Length 150cm



Basic kit
 Ref.PACK0001
 6 step hurdles - Height 15cm
 12 flat cones - Height 5cm
 1 foot speed ladder - 6m
 1 storage bag



Fundamentals kit
 Ref.PACK0002
 6 step hurdles - Height 15cm
 12 flat cones - Height 5cm
 12 training cones - Height 28cm
 1 foot speed ladder - 6m
 1 speed chute - Diameter 120cm
 1 storage bag



Plus kit
 Ref.PACK0003
 2 set of 3 step hurdles
 Heights 15cm, 28cm, 32cm
 12 training cones - Height 28cm
 1 speed ladder - Length 6m
 1 speed chute - Diameter 120cm
 1 storage bag



Training kit
 Ref.PACK0004
 1 agility ladder - Length 6m
 8 round base cones - Height 28cm
 10 step hurdles with carry strap
 Height 15cm
 1 resistance belt
 1 storage bag



Eco kit
 Ref.PACK0005
 1 agility ladder - Length 6m
 12 flat cones - Height 5cm
 1 foot speed ladder - 6m
 1 speed chute - Diameter 120cm
 1 storage bag



Fun kit
 Ref.PACK0006
 6 step hurdles - Height 15cm
 1 agility ladder - Length 6m
 10 flat cones - Height 5cm
 10 training cones - Height 22cm
 1 storage bag



Mobile storage rack
 Ref.70040 dim 55x60x94cm
 Ref.70041 dim 100x65x94cm



Mobile storage locker 1 door
 Ref.SC109 dim 100x57x112cm
 Ref.SC110 dim 80x57x157cm



Foldable ball carrying cart
 Ref.SC20



Ball carrying rack cart 156x54x143cm
 Ref.SC100



Multi-purpose carrying cart
 Ref.10107 dim 105x85x105cm



Vertical rack for medicine balls
 Ref.SC101

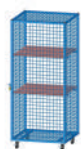

Mobile equipment storage cupboard
 Ref.SC111
 1 door - 2 shelves (84x72x188cm)

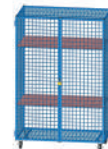

Mobile equipment storage cupboard
 Ref.SC112
 2 doors - 2 shelves (120x70x183cm)

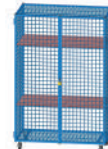

Mobile equipment storage cupboard
 Ref.SC115
 2 doors - 2 shelves (150x54x157cm)



Mobile equipment storage cupboard
 Ref.SC113
 2 doors - 2 shelves (150x54x97cm)



Mobile equipment storage cupboard
 Ref.SC114
 4 doors - 4 sections (150x54x103cm)

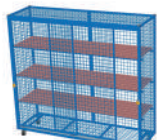

Mobile equipment storage cupboard with sliding doors
 Ref.SC116
 dim 201x65x188cm



Dima carrying bag in spike-proof fabric
 Ref.SC60
 dim 90x35x35xcm



Dima carrying bag
 Ref.SC61
 dim 90x35x35cm



Dima extra-large carrying bag
 Ref.10830
 dim 100x60x70cm

GENERAL PHYSICAL PREPARATION

STRENGTH EQUIPMENT

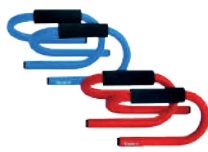

Push-up bars
Ref.70060 Per pair



Performance push-up bars
Ref.70065 Per pair



Wall bars
Ref.ESPA1 240x90cm
Ref.ESPA2 250x168cm



Traction bar for wall bars
Ref.ESPAB



Medicine ball
Ref.21300 1kg per unit
Ref.21310 1.5kg per unit
Ref.21320 2kg per unit
Ref.21330 3kg per unit
Ref.21340 4kg per unit
Ref.21350 5kg per unit



Medicine ball support belt
Ref.21370



TRX
Ref.FIT03606



Ab wheel
Ref.FIT03605



Climbing rope 6M
Ref.FIT03600



Medicine ball with handle
Ref.21354 1kg per unit
Ref.21364 2kg per unit
Ref.21366 3kg per unit
Ref.21374 4kg per unit



Dual handle medicine ball
Ref.21206 6kg per unit
Ref.21207 7kg per unit
Ref.21208 8kg per unit



Wall Ball
Réf.FIT03530 4kg
Réf.FIT03531 6kg
Réf.FIT03532 8kg
Réf.FIT03534 9kg
Réf.FIT03533 10kg



Vertical rack for medicine balls
Ref.SC101



Kettlebell Per unit
Ref.21404 4kg
Ref.21406 6kg
Ref.21408 8kg
Ref.21412 12kg
Ref.21416 16kg
Ref.21424 24kg
Ref.21432 32kg



Comfort wrist/ankle weight
Ref.70034 500gr
Ref.70028 1kg
Ref.70022 1.5kg
Ref.70023 2kg



Weighted glove 500g each
Ref.70031 Per pair



Dima weighted vest
Ref.70051 Size M (0 to 10 kg)
Ref.70052 Size L (0 to 10kg)



Elastiband
Ref.70048 10kg
Ref.70050 15kg
Ref.70049 20kg



Latex Resistance Band
Ref.FIT03880 Résistance 10kg red
Ref.FIT03881 Résistance 20kg black
Ref.FIT03882 Résistance 30kg purple
Ref.FIT03883 Résistance 40kg green



Weighted vest
Ref.70055 (0 to 10 kg)



Resistance belt with handle
Ref.70036



Jumping resistance belt
Ref.70037



Resistance cord with handles
Ref.70035



Ankle weights
Per pair - Ref.70030



Ankle resistance straps
Ref.70032 Per pair



Resistance belt (standalone)
Ref.70010 Size M
Ref.70012 Size XL



Elastic roll
Ref.10560
bungee cord - 25m
(diam 6mm)



Dual resistance trainer
Ref.70011
(2 belt+12.5 ml parablond tube)



Resistance / speed cord
Ref.9ATEL004 12.5ml



Gym / swiss ball
Ref.10367 diam 55cm
Ref.10366 diam 65cm
Ref.10368 diam 75cm



Stand for gym ball
Ref.10365



Resistance speed chute
Ref.50001 Size S (100cm)
Ref.50002 Size M (120cm)
Ref.50003 Size L (140 cm)



Power sled
Réf.70015
Traction belt
with strap and carabiner
Réf.70009

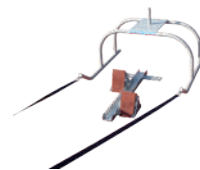

Special start power sled départ
Ref.70016



Power sled Premium
Réf.FIT01730
Power sled Classic
Réf.FIT01735



Free-standing high bar
Ref.20161



Free-standing parallel bars
Ref.24151

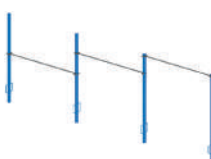

High bars without cables
Ref.70085 1 rail
Ref.70086 2 rails
Ref.70087 3 rails



Pyramid wooden gymnastic vaulting box
Ref.22326 with rollers



Wooden gymnastic vaulting box
Ref.22325 with rollers



ABMAT
Ref.FIT02601 Black
Ref.FIT02603 Red
Ref.FIT02604 Rose



HSPU mat - Foldable in 4
Ref.FIT02621 100x50x3cm
Ref.FIT02630 100x67x3cm



Gymnastic rings
Ref.FIT03610
Diam 28mm/length. 6m



Wooden gymnastic bench
Ref.BANC2 200x24x31cm
Ref.BANC3 300x24x31cm
Ref.BANC4 400x24x31cm



Utility bench
Ref.FIT01400
130x35x50cm



Dropping mats
Réf. FIT26300 80 X 66 X 26 CM
Réf. FIT26303 80 X 50 X 16 CM



Battle rope
Réf.FIT03602



Foam Plyo boxes
Ref. FIT01720 60cm
Ref. FIT01722 30cm
Ref. FIT01724 Set of 4 plyo boxes
Ref. FIT01721 50cm
Ref. FIT01723 15cm



GENERAL PHYSICAL PREPARATION

WEIGHTLIFTING, RACKS AND MOBILITY



Olympic bar

Ref.FIT03303/05 15Kg Capacity 300kg
 Ref.FIT03302 15Kg Capacity 450kg
 Ref.FIT03301/04 20Kg Capacity 450kg
 Ref.FIT03300 20Kg Capacity 800kg



Bar holder

Ref.FIT01901 (10 bars)



Wall bar holder

Ref.FIT01900 (6 bars)



Black bumper plates

Ref.FIT03320 5kg Per pair
 Ref.FIT03321 10kg Per pair
 Ref.FIT03322 15kg Per pair
 Ref.FIT03323 20kg Per pair
 Ref.FIT03324 25kg Per pair



Fractional plates

Ref.FIT03325 1kg
 Ref.FIT03326 2.5kg



Vertical plate tree

Ref.FIT01903



Spring collars

Ref.FIT03360 Per pair



Sandbag with filler

Ref.FIT02570 up to 10kg
 Ref.FIT02571 up to 20kg
 Ref.FIT02574 up to 25kg
 Ref.FIT02572 up to 40kg



Bumper plates stacker

Ref.FIT01902



Storage rack for dumbbells

Ref.FIT01904 60x162x82cm



Dumbbells

Réf.FIT03501 2kg	Réf.FIT03502 4kg	Réf.FIT03514 5kg
Réf.FIT03503 6kg	Réf.FIT03504 8kg	Réf.FIT03505 10kg
Réf.FIT03506 15kg	Réf.FIT03507 20kg	Réf.FIT03515 22,5kg
Réf.FIT03508 25kg	Réf.FIT03509 30kg	Réf.FIT03510 35kg
Réf.FIT03511 40kg	Réf.FIT03512 45kg	Réf.FIT03513 50kg



Pull-up bar 1m10

Ref.FIT01245 diam 30mm



Pull-up system

Ref.FIT01100 60x130x60cm



Pro pull up system

Ref.FIT01101 84x135x83cm



Pull-up system wall or ceiling mounts

Ref.FIT01110 60x130x60cm



Multi grips pull-up bar

Ref.FIT01150 60x130x60cm



Pro Pull-up system 2.0

Réf.FIT01140 - Simple 130x130x140cm
 Réf.FIT01141 - Double 260x130x140cm



Wall bracket

Réf.FIT02351 - 1m20x80cmx50cm
 Réf.FIT02353 - Foldable 1m20x70cm



Premium squat cage

Ref.70082



Sloping press

Ref.70081



Full body workout station

Ref.70080



Basic squat stand

Ref.FIT01210 186x80cm



Squat stand

Ref.FIT01201 120x120x240cm



Yoke

Ref.FIT01440



Power rack

Ref.FIT01202 170x120x240cm



Single wall mount rig

Ref.FIT01226 166x120x275cm
 Réf.FIT01227 - 116x122x240cm



Classical rig

Ref.FIT01220 172x290x275cm



Wall mount rig

Ref.FIT01225
 166x290x275cm



J-cups

Ref.FIT01270



Safety spotter arms

Ref.FIT01271



Dips station

Ref.FIT01275



Massage stick

Ref.FIT03861



Foam roller

Ref.FIT03860 Red
 Ref.FIT03862 Black
 Ref.FIT03863 Purple



Balance board/wobble board

diameter 35 cm height : 8cm
 Ref.KBG2110



Fitness cushion pad

Ref.FIT03830



Bosu balance trainer

Ref.FIT03850

● ATHLETICS PACKS



Athletics discovery pack - Running
Ref.70231



Athletics discovery pack - Jumping
Ref.70211



Athletics discovery pack - Multi-game
Ref.70241



Complete stadiumkit
Ref.75200
Stadium kit plus formula
Ref.75210



Club athletics beginners pack
Ref.70107



Club athletics beginners pack - throwing
Ref.70116



Club athletics beginners pack - running
Ref.70118



Athletics discovery pack - throwing
Ref.70113



Athletics discovery pack - jumping
Ref.70114



Athletics discovery pack - running
Ref.70117



Athletics discovery pack - multidiscipline
Ref.70115

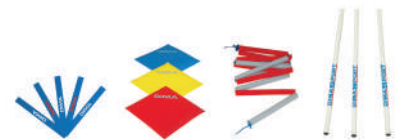

Pole vault athletics pack
Ref.70140



Pole vault plus athletics pack
Ref.70130



Foldable long jump mat
Ref.30231 200x100x20/4cm
Ref.30230 400x200x30/4cm



5-step foam stairs for long jump
Ref.30220 300x150x100cm



Take-off mat
Ref.23900 250x100x3cm

ANIM'ATHLE EQUIPMENT



Multi-functional cone hurdles
Ref.10415 Set of 3
(Height 7,20,32,cm)
Ref.10416 Set of 3
(adjustable 9,24,39 cm)



Baby trampoline
Ref.K3075 155x115x32cm



Foam javelin
Ref.11723 L'unité



Rubber rings
Ref.75110 Set of 6



Flat cone marker
Ref.10495 diam 20cm
Height 5cm Set of 20
Ref.10496 diam 20cm
Height 5cm Set of 40
Ref.10497 diam 30cm
Height 20cm Set of 20



Gymnastics mat
200x100x4cm
Ref.23510



Multi-functional flat cone hurdles
Ref.10403 Set of 10 Height 5cm
Ref.10404 Set of 10 Height 20cm



Throwing ring
Ref.75121 Set of 3 400gr
Ref.75131 Set of 3 600gr



Wooden gymnastic bench
Ref.banc2 2m
Ref.banc3 3m
Ref.banc4 4m



Multi-purpose holed marker cones with slotted top
Ref.K5010 Set of 4-4 to 37cm
Ref.K5015 Set of 4-4 to 50cm



Training markers
Ref.10372 Set of 20



Rubber hammer
Ref.13151 350gr
Ref.13154 500gr
Ref.13150 1kg
Ref.13152 1.5kg
Ref.13153 2kg



Soft rubber cone markers 18cm
Ref.10480 Set of 12



Foldable variable height step hurdles 15 & 30cm
Ref.10234 Set of 6
5 Height 15-30cm



Foam folding hurdle mat
Ref.23936 Set of 4 hurdles
Height 35cm
Ref.23940 Set of 4 hurdles
Height 50cm



Rocket javelin
Ref.11726 Set of 3
Ref.11724 Set of 6



Metric tape
Ref.10390 Bande de 20m
Ref.10395 Bande de 50m



Plastic relay baton
Ref.10181
Set of 6



Beginners fiberglass pole 2m
Ref.10080



Foam pole support
Ref.11104



Landing mattress 300x200x20cm
Ref.23050



Plastic base to be filled
Ref.10195 Per pair



Medicine ball
Ref.21300 1kg per unit
Ref.21310 1.5kg per unit
Ref.21320 2kg per unit
Ref.21340 3kg per unit
Ref.21350 5kg per unit



Standard GPP benches
Ref.10770 Height 10cm
Ref.10771 Height 20cm
Ref.10772 Height 30cm
Ref.10773 Height 40cm
Ref.10774 Height 50cm
Ref.10775 Synthetic optional

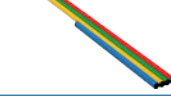

Pole diameter 25mm
Ref.K5029 Set of 8 pole Length 60 cm
Ref.K5030 Set of 8 pole Length 100 cm
Ref.K5035 Set of 8 pole Length 120 cm
Ref.K5036 Set of 8 pole Length 160 cm



Multi-functional stopwatch
Ref.15521



Multi-position high jump standards
Ref.14320

BABY ATHLE EQUIPMENT



Cross mat 150x150x1.5cm
Ref.23940



Foam gymnastic beam
Ref.24035 2m
Ref.24030 3m



Gymnastic low beam
Ref.21640 Length 3.60m
Ref.21650 Length 5.00m



Summer skis for children
Ref.KBG2108 For 2 children
Ref.KBG2148 For 3 children



Soft bean bags 12x12cm- Set of 6
Ref.JONGL185



Tactile discs mobility course (10 pieces)
Ref.KBG2117



Hemisphere stilts Set of 3
Ref.KBG2119



3 level platform foam module 160x60x100cm
Ref.22321



Mini obstacles
Ref.10345 50x12x12cm
Ref.10346 50x18x18cm



Straight line floor markers 34 x 7.5cm Set of 6
Ref.K5061



Ball toss frame set
Ref.K5135



Multicolour plastic bowling set (6 skittles + 2 balls)
Ref.K5058



River stones Set of 6
Ref.KBG2120



Juggling scarves Set of 4 (40x40cm)
Ref.KBG15382
Set of 6 (68x68cm)



Dimahop - Set of 2 (1 red & 1 yellow)
Ref.KB028407



Tug of war rope Length 10 m
Ref.K5057



Target diameter 150cm and 6 velcro balls
Ref.70096



Vertical target for throwing 130x130cm
Ref.70098



Target for throwing event landing area 300x100cm
Ref.70097



Baby athle target 150x170cm
Ref.70095



Balance board/wobble board diameter 35 cm height : 8cm
Ref.KBG2110



Target hoops
Ref.10190



Flat hoops
Ref.K5020 diam 35cm
Ref.K5022 diam 50cm
Ref.K5025 diam 60cm
Ref.K5026 diam 70cm



Square poly spots Set of 12 in a polybag
Ref.K5059



Juggling ball (diam 20 cm) Set of 12
Ref.KBG15293



Beanbag juggling ball
Ref.JONGL170
diam 62mm Set of 3
Ref.JONGL180
diam 80mm Set of 3
Ref.KBGS133
diam 60mm Set of 12



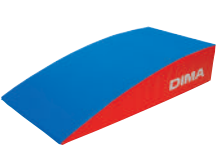

Seesaw
Ref.KBG2169





Foam springboard 120x60x25cm
Ref.22105

Equipment required to equip an outdoor stadium

	Page	Régional	National / International
RUNNING			
Lane markers	19	8	8 or 16
Starter's rostrum	19	1	1 to 3
Starting-blocks	4	6 to 8 (+2)	16 (+3)
Starting-blocks cart	4	1	1 or 2
Hurdles	5	65 to 90	90 to 130
Replacement gateboards	5	10	20
30 hurdle cart	5	2 to 3	3
8 hurdle cart	5	10	12 to 15
Steeplechase hurdle	5	1	1
Steeplechase hurdle cart	5		1
Judges' stand	19	1 or 2	1 or 2
Timers' stand	19	1	1 or 2
Lap counter + bell	19	1	1
Finishing posts (2)	19	1	1
Free lane flag	19	1	1
Free lane markers (set of 7)	19	1	1
Relay Batons (set of 4)	4	3 to 4	3 to 4
Cone marker - 20cm	21	60	60
JUMPING			
High jump landing system + Weather cover	10-11	1 (5 x 3m)	1 or 2 (6 x 4m)
Platform (for landing areas durability)	10-11	1	1 or 2
High jump shed (security)	10-11	1	1 or 2
High jump standards (2)	12	1	1 or 2
High jump elastic crossbar	12	1	1 or 2
High jump crossbar 4.00m	12	4	4 to 12
High jump height gauge	12	1	1 or 2
Stempladder	12		2 or 4
Platform (for landing area durability)	6-7	1 (7 x 5m)	1 or 2 (8 x 6m)
Pole vault landing system + Weather cover	6-7	1	1 or 2
Pole vault shed (security)	6-7	1	1 or 2
Pole vault standards (2)	7	1	1 or 2
Rails for Pole vault standards (2)	7	1	1 or 2
Pole vault standard uprights pad	7	1	1 or 2
Pole vault standard base pad	7	1	1 or 2
Pole vault bag rack	8		1 or 2
Pole vault height gauge	8	1	1 or 2
Crossbar placer (2)	8	1	1 or 2
Pole vault Crossbar 4.50m	8	4	4 to 12
Pole vault uprights adjustment indicator cart	8		1 or 2
Poles - upon request	9		
LONG/TRIPLE JUMP			
Take-off board	13	6	6 to 8
Plasticine board	13	8	10 to 12
Plasticine strips	13	6	6 to 8
Take-off board markers (2)	13		2
Long jump distance markers	13	1	2
Triple jump distance markers	13	1	2
Pit rake, broom, scraper (set)	13	2	2
10m Steel measuring tape	19	2	2
20m Steel measuring tape	19	2	2
Plasticine boards cart	13		2
Sand pit cover (cleanliness)	13		2 to 4

	Page	Régional	National / International
THROWING			
Hammer Cage (mixed)	16	1	1
Hammer conversion circle	16	according to config.	
Rolling Strips for IAAF panels	16		1
Hammer cart	17	1	1
Discus cart	17	1	1
Shot put cart	17	1	1
Javelin cart	18	1	1
Discus cage	16		1
Anti-rebound net	16		1
Shot put toeboard	16	1	2
Shot put channel	17		1 or 2
Short throwing distance marker box	18		2 sets of 10
Long throwing distance marker box	18		2 sets of 10
Short Throwing distance field markers (set of 12)	18	2	2
Long throwing distance field markers (set of 12)	18	2	2
50m plastic sector line (boundary)	18	6	8
Sector line cart	18		4
Fixing Staples (set of 100)	18	1	2
Free Lane Flag (2)	18		3
100m Steel measuring tape	19	1	1
30m Steel measuring tape	19	2	2
Hammer spare wires	17	5	
Throwing Equipment certification unit	18		1
Throwing equipment upon request	17-18	3 of each	3 of each
STADIUM ENVIRONMENT			
Sector flags + fixing pegs	19		200m
Officials flags white/red (2)	18	10	10
Officials flags yellow (2)	18	10	10
Officials clipbord	19	10	20
Performance indicator cart	19	5	8 to 10
Electronic countdown clock	19		6 to 8
Wind indicator	19	3	4 to 6
Wind gauge	19	2	2 to 4
Wind sock	19	5	6 to 8
Chalk bowl (+ chalk blocks)	19	2	2 to 4
Take-off markers (set of 10)	19	5	6 to 8
Crossbar cart	8-12		2
Mini steeplechase barriers	5		1
Awards' stand	19	1	1
Equipment cart	12-21	1	2
Measuring wheel	19		1
EQUIPMENT TO BE FIXED DOWN			
Take-off board foundation tray	13	6	6 to 8
Take-off board lid	13	6	6 to 8
Vault box	8	1	2
Vault box lid	8	1	2
Shot put /hammer circle with cross bracing	16	2	3
Discus circle with cross bracing	16	1	2
Hammer cage ground sleeves	16	1	1
Discus cage ground sleeves	16	1	1
Finish post ground sleeves	19	1	1
Water jump hurdle ground sleeves	5	1	1
SCHOOLS AND ATHLETICS ORGANISATIONS EQUIPMENT		20-21-24-25	

Equipment required to equip an indoor stadium

	Page	Régional	National / International
RUNNING			
Lane markers	19	6 to 8	6 to 16
Starter's rostrum	19	1	1 or 2
Starting-blocks	4	6 to 8 (+2)	8 (+2)
Starting-blocks cart	4	1	1
Hurdles	5	30 to 40 (+5)	30 to 40 (+5)
Replacement gateboards	5	10	20
8 hurdle cart	5	5	5
Judges stand	19	1 or 2	1 or 2
Finishing posts (2)	19	2	2
Lap counter + bell	19	1	1
Sector flag	19	1	1
Free lane markers (set of 7)	19	1	1
Relay Batons (set of 4)	4	3	3
Finish protection pad 	12	1	1
JUMPING			
High jump landing systems	10-11	1 (5 x 3m)	1 (6 x 4m)
High jump standards (2)	10-11	1	1
High jump elastic crossbar	12	1	1
Crossbar 4.00m	12	4	6 to 8
High jump height gauge	12	1	1
3 rung step ladder	12		2
Pole vault landing standards	6-7	1 (7 x 5m)	1 (8 x 6m)
Pole vault standards (2)	7	1	1
Rails for pole vault standards (2)	7	1	1
Pole vault standards protection pad (2)	7	1	1
Pole vault standards base pad (2)	7	1	1
Pole vault bag rack	8		1
Pole vault height gauge	8	1	1
Cross bar placer (2)	8	1	1
Cross bar 4.50m	8	4	6 to 8
Pole vault standards adjustment display panel	8		1
Poles - upon request	9		
LONG/TRIPLE JUMP			
Take-off board	13	6	6 to 8
Plasticine board	13	8	10 to 12
Plasticine strips	13	6	6 to 8
Plasticine board cart	13		2
Take-off board markers (2)	13		2
Long jump distance markers	13	1	2
Triple jump distance markers	13	1	2
10m Steel measuring tape	19	2	2
20m Steel measuring tape	19	2	2
Pit rake, broom, scraper (set)	13	1	1

	Page	Régional	National / International
THROWING			
Indoor shot put circle with toeboard	16	1	1
Shot put throwing cage (height 4m)	16	1	1
Shot put landing area (mat)	16	150 to 200m ²	150 to 200m ²
Shot put cart	17	1	1
Shot put channel	17		1
Short throwing markers (set of 10)	18		2
50m plastic sector line (boundary)	18	1	1
Sector line cart	18		1
30m Steel measuring tape	19	1	1
Throwing Equipment Certification unit	18		1
Throwing equipment upon request	17-18	3 of each	3 of each
STADIUM ENVIRONMENT			
Sector flags + fixing pegs	19		100m
Awards' stand	19	1	1
Landing area locking platform	12		2
Electronic count down clock	19		4 to 6
Performance indicator cart	19	5	5 to 7
Chalk bowl (+ chalk blocks)	18	2	2
Take-off markers (set of 10)	19	5	6 to 8
Officials' flags white/red (2)	18	6	6
Officials' flags yellow (2)	18	6	6
Officials's clipboard	19	10	20
Equipment cart	12-21	1	1
EQUIPMENT TO BE FIXED DOWN			
Take-off board foundation tray	13	6	6 to 8
Take-off board lid	13	6	6 to 8
Removable vault box	8	1	3



Competition Info.

- Performance indicator cart: 1 per competition
 - Electronic countdown clock: 1 per competition
 - Wind gauge: 1 per track and competition (long jump & triple jump)
- Equipment desirable but not mandatory.**

INDOOR CAGE PLAN

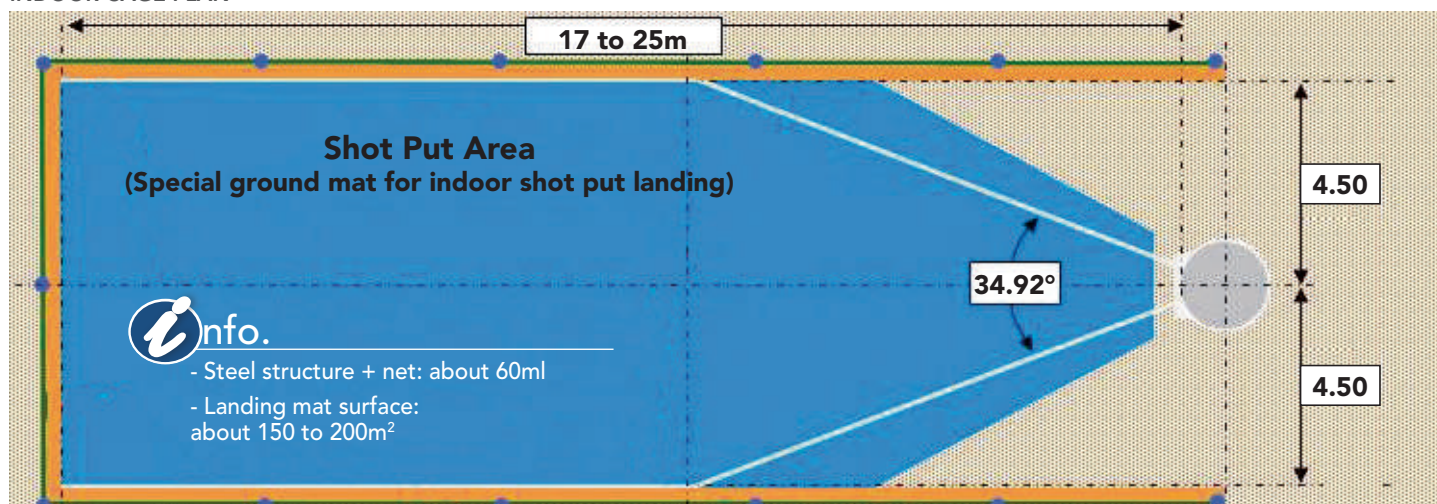

MADE TO MEASURE

Designer, manufacturer and distributor for more than 50 years, Dimasport puts its experience at your service. Passionate and committed to the sport and athlete world, Dima manufacture in France the custom-made equipment you need.

Thanks to our engineering team, we can assist you and carry out your project.



**YOU HAVE AN IDEA OR HAVE A SPECIFIC NEED,
DO NOT HESITATE TO CONTACT US!**

☎ 00 33 1 64 40 05 70 @ info@dimasport.fr



Custom made finish protection pad jumping module



Made to measure

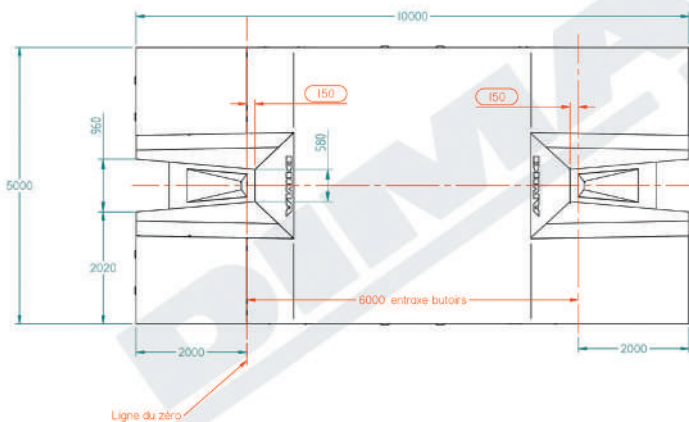

Vault box interaxial adapted
double-front landing system



Portable raised running track:
Raised with the requested inclination

MADE IN FRANCE

We manufacture our products in our own factories
in Ozoir-la-Ferriere near Paris.

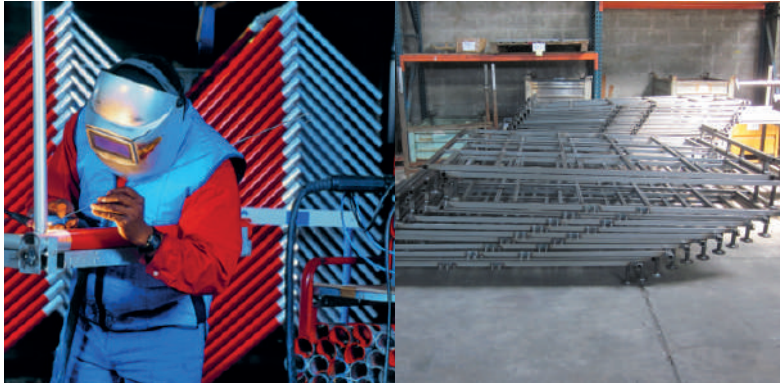

METALWORK

We cut, drill and weld the steel ourselves.
Every production stage is rigorously controlled.



TARPAULINS

For over 50 years, we have been constantly improving our processing
methods to offer top-quality products.



Atelier Obol

Dima also makes throwing implements: discusses, hammers
and javelins are manufactured in our factory.

Dima is the only French company to make its own throwing implements.

RAW MATERIALS



Our foams are of the highest
quality and we know their composition.



Our canvases are inspected and certified.



We select our steels carefully and we know
where they come from.

We require unremittingly high standards from our suppliers, because the quality of our raw materials largely guarantees the quality of our products. Foam is a costly but fundamental component in our products; we are constantly attentive to its quality and make no compromises.

MANUFACTURER AND DISTRIBUTOR. DIMA ENSURES FULL INVOLVEMENT

MADE IN

DIMASPORT

FRANCE

POLE-VAULT REGULATIONS

Official Supplier
of **ATHLÉ**
French Athletics Federation



WORLD ATHLETICS LEVEL 1

Other competitions World Athletics + Departmental, regional & national level [FFA]

- LANDING SYSTEM:
Minimum dimensions of 5.00 x 5.00 x 0.80m
(not including front extensions)
- FRONT EXTENSIONS:
Minimum length of 2 m
Overall dimensions: 7.00 x 5.00 x 0.80m

WORLD ATHLETICS LEVEL 2

Championships and international meetings +
Exception: Elite French Championship [FFA]

- LANDING SYSTEM:
Minimum dimensions of 6.00 x 6.00 x 0.80m
(not including front extensions)
- FRONT EXTENSIONS:
Minimum length of 2 m
Overall dimensions: 8.00 x 6.00 x 0.80m

Tested in laboratory conditions,
our landing systems conform to **NF EN 12503-2 type 11**
standards, as required by federation rules.

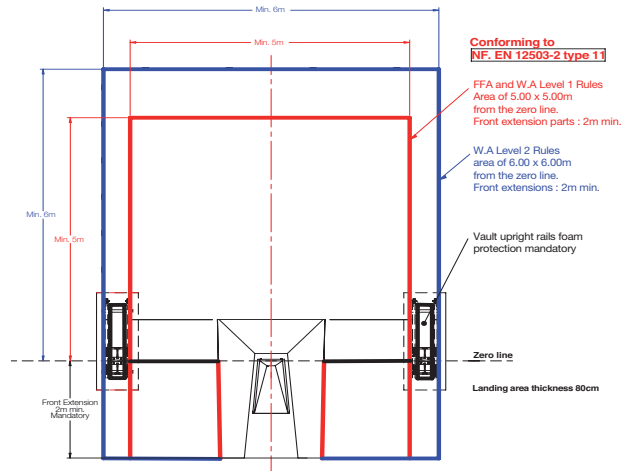

Regulations at all levels (F.F.A & W.A) require "protection of pole-vault uprights bases using padding made from the appropriate materials"

See pole-vault standard base pad p. 7

The white "zero line" is shown ON ALL DIMA LANDING SYSTEMS in compliance with F.F.A & W.A regulations.

TO HELP YOU CHOOSE!

1 Select your type of landing system

3 Various landing system designs are offered to you, for optimum suitability:
quality/price/functionality

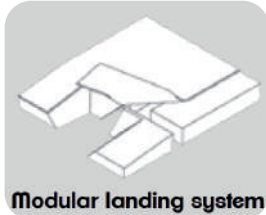

Modular landing system

1. MODULAR SYSTEM

Composition: Airfoam units individually encased, lockable, interchangeable and transportable, covered with a 7 or 10cm thick anti-spike top pad, for a uniform, comfortable and flexible landing system.

Advantages

- Good level of comfort
- Reversible blocks assembly for longer life
- Allows for easier assembly, moving, and storage (for pole vaulting landing systems, rapid moving of the blocks if the wind changes).



Comfort Plus Single Cover landing system

2. COMFORT PLUS SINGLE COVER LANDING SYSTEM

Composition: Airfoam units encased in a single cover, covered with a 7 or 10cm thick anti-spike top pad, for great comfort and flexibility.

Advantages

- Very good quality/price balance.

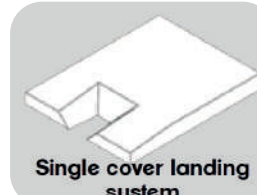

Single cover landing system

3. SINGLE COVER LANDING SYSTEM

Composition: Airfoam units encased in a single cover, with the top surface made of anti-spike fabric.

Advantages

- Price

2 Shed options

Shed for security and care (see all sheds on pages 6 to 7).

HIGH JUMP REGULATIONS

Official Supplier
of **ATHLÉ**
French Athletics Federation



WORLD ATHLETICS LEVEL 1

Other competitions + Regional level [FFA]

- LANDING SYSTEM:
Minimum dimensions of 5.00 x 3.00 x 0.70m

WORLD ATHLETICS LEVEL 2

Championships and international meetings +
National / Elite level [FFA]

- LANDING SYSTEM:
Minimum dimensions of 6.00 x 4.00 x 0.70m

Tested in laboratory conditions,
our landing systems conform to **NF EN 12503-2 type 11**
standards, as required by federation rules.

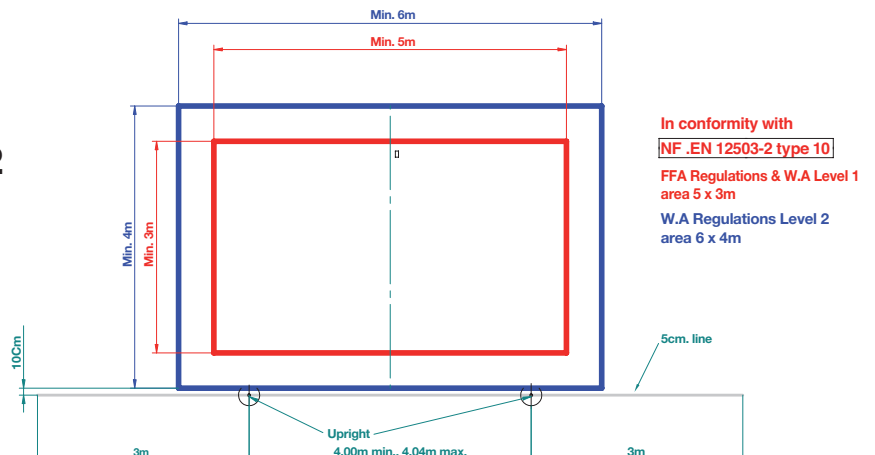

- A**
- ABMAT p. 22
 - Ab wheel p. 22
 - Adjustable GPP foam hurdle p. 5, 20
 - Airfoam replacement units p. 12
 - Aluminium auto return hurdles p. 5, 20
 - Aluminium discus cage p. 16
 - Aluminium height gauge p. 12
 - Aluminium school high jump height p. 12
 - Aluminum drainage dome p. 8, 12
 - Aluminum hammer cage p. 16
 - Ankle p. 22
 - Anti-rebound safety net p. 16
 - Athletics packs p. 24
- B**
- Baby hurdle p. 5, 20
 - Baby trampoline p. 25
 - Bag for hoops p. 21
 - Bag for starting blocks p. 4
 - Balance board/wobble board p. 23, 25
 - Ball toss frame set p. 25
 - Banner fixing post p. 19
 - Bar holder p. 23
 - Base p. 21, 25
 - Basic chalk bowl p. 8, 18
 - Basic squat stand p. 23
 - Beanbag juggling ball p. 25
 - Beginners fiberglass pole p. 25
 - Belt p. 22
 - Bench p. 13, 20, 22, 25
 - Black bumper plates p. 23
 - Blanking lid p. 13
 - Bosu balance trainer p. 23
 - Bracket p. 7
 - Bricks p. 21
 - Bumper plates stacker p. 23
- C**
- Carrying cart for starting blocks p. 4
 - Case of 24 digi DT1 stopwatches p. 4
 - Chalk/magnesia p. 8, 18, 19
 - Classical rig p. 23
 - Climbing rope p. 22
 - Club athletics pack throwing p. 18
 - Comet ball p. 18
 - Comfort wrist/ankle weight p. 22
 - Competition high jump crossbar p. 12
 - Competition pole-vault crossbar p. 8
 - Competition take-off board p. 13
 - Competition telescopic height gauge with pointer p. 8
 - Competition telescopic high jump height p. 12
 - Cone p. 20, 21, 25
 - Cranking handle p. 7
 - Cross-braced hurdles p. 5
 - Crossing ladder p. 23
 - Cross mat p. 20, 25
 - Customized printing p. 12
- D**
- Digi DT 2500 P stopwatch with integrated printer p. 4
 - Dima carrying bag p. 21
 - Dimahop p. 25
 - Dimakid hurdles p. 5, 20
 - Dima official's clipboard p. 8, 19
 - Dips station p. 23
 - Discus p. 17
 - Discus bag p. 17
 - Discus circle p. 16
 - Distance measuring wheel p. 19
 - Dropping mats p. 22
 - Drying surface roller p. 12, 19
 - Dual resistance trainer p. 22
 - Dumbbells p. 23
- E**
- Elastiband p. 22
 - Elastic roll p. 22
 - Elastic roll/bungee cord - 25m p. 8, 12
 - Elastic tape crossbar p. 8, 12
 - Electronic countdown timer p. 19
 - Electronic weighing scale for athletics throwing devices p. 18
 - End-assembling gymnastics track p. 20
 - Equipment cart with towing bracket p. 12
 - Equipment shed p. 15
 - Exercise/Yoga mat p. 20
 - Extra large cylinder foam p. 20
- F**
- Finish posts p. 19
 - Finish protection pad p. 12, 19
 - Fitness cushion pad p. 23
 - Fixed pole rack p. 8
 - Fixing staples p. 18
 - Flag football/rugby belt p. 21
 - Flat cone marker p. 20
 - Foam drainage dome p. 8, 12
 - Foam elastic crossbar p. 8, 12
 - Foam folding hurdle mat p. 5, 20, 25
 - Foam gymnastic beam p. 25
 - Foam hurdle p. 5, 20
 - Foam javelin p. 25
 - Foam Plyo boxes p. 20, 22
 - Foam plyometric box p. 20
 - Foam pole support p. 8, 25
 - Foam protection pad p. 16
 - Foam roller p. 23
 - Foam springboard p. 25
 - Foldable long jump mat p. 24
 - Foldable variable height step hurdles p. 5, 20, 25
 - Foul board cart p. 13
 - Foul board for competition take-off board p. 13
 - Frame for reversible take-off board p. 13
 - Free lane cone markers p. 19
 - Free lane flag p. 19
 - Free-standing high bar p. 22
 - Free-standing parallel bars p. 22
 - Full body workout station p. 23
 - Fully assembling gymnastics school mat p. 20
- G**
- Galvanized platform p. 6, 7, 10, 11, 12
 - GPP hurdles p. 5, 20
 - Grass track line marker p. 19
 - Gymnastic low beam p. 25
 - Gymnastic rings p. 22
 - Gymnastics mat p. 25
 - Gym / swiss ball p. 22
- H**
- Hammer case p. 17
 - Hammer conversion circle p. 16
 - Hammer globe p. 17
 - Hammers p. 17
 - Hammer training replacement handle p. 17
 - Heavy throwing weight p. 17
 - Hemisphere stilts p. 25
 - High jump p. 12
 - High jump landing p. 10, 11
 - High jump standard cart/trolley p. 12
 - High jump standards p. 25
 - Hoops p. 21, 25
 - Hoop wall bracket p. 21
 - HSPU mat p. 22
 - Hurdle carts p. 5
- I**
- Implement certification kit p. 18
 - Individual training mat p. 20
 - Indoor shot put throwing landing system p. 16
 - Installation tray for competition take-off board p. 13
 - Integral pole vault shed p. 14
 - International hurdle p. 5
- J**
- Javelin p. 18
 - Javelin carrying case p. 18
 - Javelin display rack p. 18
 - Javelin/poles carrying tube p. 18
 - J-cups p. 23
 - Juggling ball p. 25
 - Juggling scarves p. 25
 - Jump distance indicator boards p. 13
 - Jump PVC distance indicator board p. 13
- K**
- Kettlebell p. 22
 - Kit p. 21
 - Knocken ball p. 18
- L**
- Ladder p. 20
 - Landing mattress p. 25
 - Lane marker box p. 4, 19
 - Laser distance measuring system p. 19
 - Laser optic measuring device p. 13, 19
 - Long jump p. 13
- M**
- Massage stick p. 23
 - Mat winder with mandrel p. 19
 - Measuring tape p. 19
 - Medicine ball p. 22, 25
 - Medicine ball support belt p. 22
 - Medicine ball with handle p. 17
 - Megaphone p. 4, 19
 - Metric tape p. 18, 25
 - Mini high-jump crossbar placer p. 12
 - Mini hurdle p. 20
 - Mini obstacles p. 5, 20, 25
 - Mini steeplechase barrier p. 5
 - Mobile discus rack p. 17
 - Mobile hammer rack p. 17
 - Mobile pole rack p. 8
 - Mobile shot rack p. 17
 - Mobile storage locker p. 21
 - Mobile storage rack p. 21
 - Mobility course equipment p. 21
 - Multi-activity pack p. 21
- Multicolour plastic bowling p. 25**
- Multi-functional hurdles p. 20**
- Multi-function hurdles p. 21**
- Multi-purpose carrying cart p. 18, 21**
- N**
- Net p. 16
 - Nylon pinnies p. 21
- O**
- Officials' flags red/white p. 8, 18
 - Officials' flags yellow p. 8, 18
 - Olympic bar p. 23
- P**
- Paper roll for printer for DT 2000 stopwatch p. 4
 - Pedometer p. 19
 - Performance indicator cart p. 19
 - Pike-proof top pad p. 12
 - Platform foam module p. 25
 - Plasticine load p. 13
 - Plasticine spatula p. 13
 - Plastic sector line p. 18
 - Plate storage pin p. 23
 - Poles p. 9, 21, 25
 - Pole stacking shed p. 8, 15
 - Pole vault p. 6, 7
 - Pole vault kit p. 8
 - Pole-vault rail base pad p. 7
 - Pole-vault uprights p. 7
 - Pole-vault upright setting indicator board p. 19
 - Portable discus throwing circle p. 16
 - Portable pole rack p. 8
 - Portable raised running track unit width p. 19
 - Portable shot put throwing platform p. 16
 - Post for section banner p. 19
 - Power rack p. 23
 - Power sled p. 4, 22
 - Premium squat cage p. 23
 - Printer for DT 2000 stopwatch p. 4
 - Protection pad p. 7
 - Pull-up bar p. 23
 - Push-up bars p. 22
 - PVC training hurdle adjustable p. 5
- R**
- Rack p. 21, 22
 - Rails p. 7
 - Relay batons p. 4, 19, 25
 - Replacement cover p. 12
 - Resistance cord with handles p. 22
 - Resistance speed chute p. 22
 - Resistance/speed cord p. 22
 - Reversible take-off board p. 13
 - River stones p. 25
 - Rocket javelin p. 18, 25
 - Rolling rack for crossbars p. 8
 - Rolling Rack For Crossbars p. 12
 - Rolling strips p. 16
 - Rostrum p. 4, 19
 - Rotating clips p. 21
 - Round javelin rack p. 18
 - Rubber hammera p. 25
 - Rubber rings p. 17, 25
- S**
- S23571 Seiko stopwatch with integrated printer p. 4
 - Safety spotter arms p. 23
 - Sandbag p. 23
 - Sand border p. 13
 - Sand pit broom p. 13
 - Sand pit cover p. 13
 - Sand pit rake p. 13
 - Sand pit scraper p. 13
 - Sand pit shovel p. 13
 - School hurdle p. 5, 20
 - School mini-hurdle p. 5, 20
 - Section banners p. 19
 - Sector flags p. 18
 - Sector line cart p. 18
 - Seesaw p. 25
 - Set of 10 hands + 10 feet floor markers p. 21
 - Set of game markers p. 21
 - Set of markers p. 21
 - Shed for hurdle carts p. 5
 - Shed on swiveling wheels carts p. 15
 - Shot case p. 17
 - Shot/hammer circle p. 16
 - Shot put p. 17
 - Shot put channel p. 17
 - Shot toeboard p. 16
 - Skipping roper p. 20
 - Sloping press p. 23
 - Soft bean bags p. 25
 - Spare hammer cable p. 17
 - Special start power sled p. 4
 - Spring collars p. 23
 - Square poly spots p. 25
 - Squat stand p. 23
 - Stacking plinths p. 20
 - Stadium kit p. 24
- Standard high jump shed p. 19**
- Standard pole vault shed p. 15**
- Standard pole vault shed p. 14**
- Stand for gym ball p. 22**
- Start clapper board p. 4, 19**
- Starting block p. 4**
- Steel distance indicator stand p. 13**
- Steeplechase barrier p. 5**
- Steeplechase barrier set transportation cart p. 5**
- Steeplechase water jump barrier p. 5**
- Steeplechase water jump cover p. 5**
- Step foam stairs for long jump p. 24**
- Step hurdle carry strap p. 5**
- Step hurdles p. 5, 20**
- Step ladder - 2 steps p. 12, 19**
- Stopwatch p. 25**
- Stopwatch p. 4**
- Storage rack for dumbbells p. 23**
- Straight line floor markers p. 25**
- Summer skis for children p. 25**
- Support for foldable pole-vault standards p. 7**
- Surround protection structure p. 16**
- Swivelling wheels for pole stacking shed p. 8, 15**
- T**
- Tactile discs mobility course p. 25
 - Take-off board markers p. 13
 - Take-off markers p. 8, 19
 - Take-off mat p. 24
 - Tape skate kit p. 13
 - Target p. 18, 25
 - Target hoops p. 18
 - Throwing area p. 18
 - Throwing distance field markers p. 18
 - Throwing distance marker box p. 18
 - Throwing ring p. 17, 25
 - Timing platform with camera stand p. 19
 - Training hurdles p. 5
 - Training markers p. 25
 - Training synthetic track roll p. 19, 20
 - TRX p. 22
 - Tug of war rope p. 25
 - Turbo javelin p. 18
- V**
- Vault box p. 8
 - Vault box lid p. 8
 - Vehicle towing bracket for hurdle cart p. 5
 - Vertical plate tree p. 23
 - Vertical transportation cart p. 12
 - Vinyl tape p. 21
- W**
- Wall ball p. 22
 - Wall ball target p. 23
 - wall bars p. 22
 - Weather cover p. 6, 7, 10, 11, 12
 - Weather cover for 8 hurdle p. 5
 - Weighted ball p. 17
 - Weighted glove p. 22
 - Weighted vest p. 22
 - Whistle p. 19
 - Wind gauge p. 19
 - Windsock p. 8, 19
 - Wind speed indicator cart p. 19
 - Wireless sprint timing system p. 4
 - Wooden adaptor for competition take-off board p. 13
 - Wooden beam p. 5
 - Wooden gymnastic vaulting box p. 22
- Y**
- Yoke p. 23

DIMASPORT

Sports Equipment

1 bis, rue Louis Armand - B.P 91- 77834 OZOIR-LA-FERRIERE CEDEX France

Tél : +33 1 64 40 05 70 – Fax : +33 1 64 40 00 37

www.dimasport.fr – info@dimasport.fr

NEW :
WITH WATERPROOF ZIPPER

Dima Sport Bag

Réf.10801F / 10802F / 10805F

Large bag Blue/Red/Black

Réf.10790F / 10789F / 10794F

Small bag Blue/Red/Black



Custom Dima Sport Bags

Réf.10832F / 10833F / 10850F

Large bag Blue/Red/Other colors on request

Réf.10834F / 10791F / 10851F

Small bag Blue/Red/Other colors on request



Dima Blue White Red Bag

Réf.10810F Large bag

Réf.10809F Small bag



Find all our products and prices online

WWW.DIMASPORT.FR