

# DIMASPORT

Sports Equipment  
**TRACK AND FIELD**

Official Supplier  
of **ATHLÈ**  
French Athletics Federation





# CONTENTS

	STARTING-BLOCKS - P4 STOPWATCHES - P4 START - P4 HURDLES - P5
◆ <b>RUNNING</b>	
	POLE VAULT - P6 to 9 HIGH JUMP - P10 to 12 LONG JUMP - P13
◆ <b>JUMPING</b>	
	POLE VAULT SHEDS - P14 HIGH JUMP SHEDS - P15
◆ <b>SHEDS</b>	
	THROWING CAGES - P16 THROWING IMPLEMENTS - P17 THROWING ACCESSORIES - P18
◆ <b>THROWING</b>	
	START/FINISH - P19 STADIUM MATERIAL - P19 MEASURING DEVICES - P19
◆ <b>STADIUM ENVIRONMENT</b>	
	PLYOMETRIC AND AGILITY - P20 TRAINING/DRILLS KITS AND EQUIPMENTS - P21 STORAGE EQUIPMENT - P21 STRENGTH EQUIPMENT - P22
<b>GENERAL</b>	
◆ <b>PHYSICAL PREPARATION</b>	
	PACKS / STADIUM KITS - P24 ANIM'ATHLE AND BABY ATHLE - P25
◆ <b>ATHLETICS GAMES</b>	
	OUTDOOR STADIUM EQUIPMENT - P26 INDOOR STADIUM EQUIPMENT - P27
◆ <b>THE STADIUM</b>	
◆ <b>MADE TO MEASURE</b>	- P28
◆ <b>ABOUT DIMA</b>	- P30
◆ <b>INDEX</b>	- P31
◆ <b>THE DIMA BAG</b>	- P32

Dimasport equips the largest sporting events and meetings with its IAAF-compliant equipment and its certified top-level competition products.

World Athletics (formerly IAAF) certified items can easily be identified by the  and their references are marked in blue [Ref.13288](#).

Concerning the landing areas (Pole Vault and High Jump), the levels of classification are indicated as follows :

- ◆ Compliant with FFA and International rules 
- ◆ Compliant with FFA and International rules   
(such as Worldwide championships, IAAF meetings and Olympic games)



Tested by a laboratory, all our landing systems are NF-EN 12503-2 type 11 certified, in accordance with the federal competition rules.



# DIMA WEBSITE

FIND ALL PRODUCT DETAILS, PRICES, PLANS AND CERTIFICATIONS ON [DIMASPORT.FR](http://DIMASPORT.FR)

Look for a product with its name or reference

The screenshot shows the DIMASPORT website interface. At the top, there is a navigation bar with the DIMASPORT logo and the tagline 'EQUIPEMENTS SPORTIFS'. Below the navigation bar, there is a search bar with a magnifying glass icon. The main content area displays a product page for 'MATELAS PERCHE INTERNATIONAL MODULAIRE 8.00 X 6.00 X 0.87/0.47 M'. The product image shows a blue and red mat. To the right of the image, there is a list of product details: 'FICHE PRODUIT (AVEC PRIX)', 'FICHE PRODUIT (SANS PRIX)', 'CERTIFICATION', 'DIMENSIONS HORS TOUT', 'PLAN D'ENVIRONNEMENT DU PRODUIT', and 'PLAN DE MONTAGE'. Below the product image, there is a price tag of '15 480,00 € TTC' and two buttons: 'AJOUTER AU PANIER' and 'AJOUTER AU DEVIS'. At the bottom of the page, there are sections for 'PRODUITS SIMILAIRES' and 'PRODUITS COMPLÉMENTAIRES'.

Consult our item descriptions, photos, zooms as well as our prices

Place an order or ask for a quotation in a few clicks

View or download our plans, certifications and other useful documents

## A DEDICATED CUSTOMER SERVICE

CONTACTING US IS VERY EASY :

+33 1 64 40 05 70

1 bis rue Louis Armand BP 91

+33 1 64 40 00 37

77834 Ozoir-La-Ferrière cedex

info@dimasport.fr

www.dimasport.fr

# DIMA

## Official Supplier of **ATHLÉ**

French Athletics Federation

## STARTING-BLOCKS



Rubber starting block - Per pair  
Ref.10112

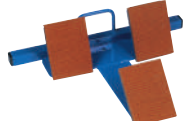

Tripod starting block  
Ref.10117

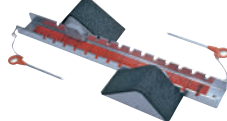

Schools starting blocks  
Ref.10113



Physical education starting blocks  
Ref.10120



Training starting blocks  
Ref.10116



Competition/Club starting block  
Ref.10114



Competition starting blocks -  
Wide pedals Ref.10102



Elite competition starting blocks  
Ref.10100



Bag for starting blocks  
Ref.10101

More details on  
 [dimasport.fr](http://dimasport.fr)



## STARTING-BLOCKS CARTS



Carrying cart for 8 starting  
blocks on the flat Ref.10105



Compact starting blocks cart  
for 8 starting blocks Ref.10104

## POWER SLEDS



Power sled  
Ref.70015



Special start power sled  
Ref.70016

## STOPWATCHES



Case of 24 digi DT1 stopwatches  
Ref.15525



Basic stopwatch  
Ref.15534



Multi-functional stopwatch  
Ref.15521



Coach stopwatch  
Ref.15532



Trainer stopwatch  
Ref.15522



Major stadium stopwatch  
Ref.15523



Pro solar stopwatch  
Ref.15529



DT 2000 Stopwatch  
Ref.15531



Printer for DT 2000 stopwatch  
Ref.15526



Data-transfer software to PC for  
DT2000 stopwatch  
Ref.15526010



Paper roll for printer for  
DT 2000 stopwatch  
Set of 10 - Ref.15526020



Digi DT 2500 P stopwatch with  
integrated printer Ref.15528



S23571 Seiko stopwatch with  
integrated printer Ref.15527



Wireless sprint timing system  
Ref.15524

## START



Lane marker box - Per unit  
Ref.10160



Steel starter's rostrum  
Ref.10920



Wooden starter's rostrum  
Ref.10922



Aluminum relay batons  
Set of 4 Ref.10180



Plastic relay baton  
Set of 6 Ref.10181



Start clapper board  
Ref.10500



Megaphone range 100m  
Ref.10600



Megaphone range 1000m  
Ref.10601

## ● COMPETITION HURDLES



Electro-galvanized international hurdle Ref.10260



Painted international hurdle Ref.10240



Painted aluminum international hurdle Ref.10270



World championship aluminum prestige hurdle Ref.10290



European championship aluminum prestige hurdle Ref.10291



Electro-galvanized automatic international hurdle Ref.10261

\*Replacement PVC hurdle board for club/international hurdle Ref.10310

\*Customized PVC hurdle board for international hurdle Ref.10312

\*Prestige PVC replacement hurdle board for aluminum hurdle Ref.10707

\*PVC customized crossbar for aluminum hurdle Ref.10706

## ● TRAINING HURDLES



Electro-galvanized club hurdle Ref.10300



Aluminum club hurdle Ref.10272



Special educational club hurdle Set of 5 - Ref.10301

## ● SHED FOR HURDLE CARTS 3.70x3.30x1.70m



Shed on swiveling wheels for 2 hurdle carts Ref.15550



Shed on swiveling wheels for 3 hurdle carts Ref.15560

## ● HURDLE CARTS



Cart for 8 international hurdles Ref.10296



Cart for 8 prestige/international aluminium hurdles Ref.10295



Weather cover for 8 hurdle cart Ref.10298



Hurdle cart for 30 hurdles Ref.10701



Vehicle towing bracket for hurdle cart Ref.10700001



Cart for 60 competition hurdles Ref.10710

## ● INITIATION/TRAINING HURDLES

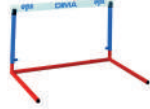

School hurdle Set of 3 Ref.10330 Set of 6 Ref.10336

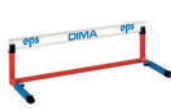

School mini-hurdle Set of 3 Ref.10230 Set of 6 Ref.10236



Replacement hurdle board for school hurdle Ref.10380



Rubber support for school hurdle board Per unit Ref.10320011

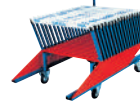

20 School hurdle cart Ref.10020



30 School hurdle cart Ref.10021



Mini obstacles 50x12x12cm Ref.10345



Foldable PVC training hurdles - Set of 10 Height 20cm Ref.10323 Height 30cm Ref.10324 Height 40cm Ref.10325 Height 50cm Ref.10326



Aluminium auto return hurdles Set of 3 Ref.10210



50x18x18cm yellow Ref.10346



Adjustable GPP foam hurdle Set of 5 Ref.10339



Cross-braced hurdles Height 22 to 106cm Set of 6 Ref.10239



Dimakid hurdles - Set of 6 Height 20cm Ref.10350 Height 40cm Ref.10355 Height mixed (20 et 40cm) Ref.10360



Baby hurdle Set of 3 Ref.10235 Set of 6 Ref.10238 Board Set of 5 Ref.10235002



PVC training hurdle adjustable Set of 3 (Height 40 to 60cm) Ref.10331 Set of 3 (Height 55 to 95cm) Ref.10337 Set of 6 (Height 40 to 60cm) Ref.10332



GPP hurdles adjustable - Set of 3 Height 20-30cm Ref.10333 Height 40-60cm Ref.10334



Foldable variable height step hurdles Set of 6 Ref.10234



Step hurdles Set of 6 (Height 15cm) Ref.10232 Set of 6 (Height 30cm) Ref.10233



Step hurdle carry strap Ref.10237



Foam hurdle L100cm x H40cm Ref.10340

## ● STEEPLE CHASE BARRIERS



\* Steeplechase barrier 4 m Ref.10951



\* Steeplechase barrier 5 m Ref.10953



Mini steeplechase barrier (76-91cm) Ref.10979



\* Steeplechase water jump barrier with surface mount Ref.10944



\* Steeplechase water jump barrier with ground sleeves Ref.10943



Steeplechase water jump cover Ref.10945



Replacement wooden beam 3.66m Ref.10955001



Replacement wooden beam 4m Ref.10956001



Replacement wooden beam 5m Ref.10958001



Replacement wooden beam for mini steeplechase barrier Ref.10959



Steeplechase barrier transportation cart Ref.10957



Cart for steeplechase barrier Per pair Ref.10954



# JUMPING



## ● BASIC POLE VAULT LANDING SYSTEM 4.25X5X0.60/0.40M



Basic pole vault landing system  
Ref.17250



Weather cover  
Ref.17251

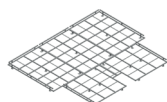

Galvanized platform  
Height 10cm  
Ref.14045

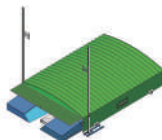

Standard Shed  
Fixed wheels Ref.15510F  
Swivelling wheels Ref.15510

## ● CLUB POLE VAULT LANDING SYSTEM 6.30X5M



Club modular pole vault landing system  
6.30x5.00x0.80/0.50m  
Ref.19160

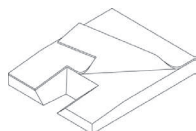

Club comfort plus single cover landing system  
6.30x5.00x0.80/0.50m  
Ref.19165

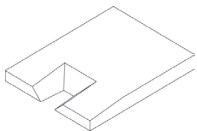

Club single cover pole vault landing system  
6.30x5.00x0.73/0.43m  
Ref.19166



Weather cover  
Ref.19161 Height 0.80m  
Ref.19167 Height 0.73m

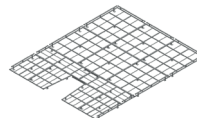

Galvanized platform  
Height 10cm  
Ref.14081

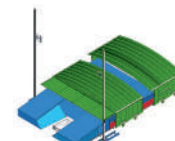

Standard Shed  
Fixed wheels Ref.15506F  
Swivelling wheels Ref.15506



Integral shed  
Fixed wheels Ref.15506FI  
Swivelling wheels Ref.15506I

## ● MEETING POLE VAULT LANDING SYSTEM 7X5X0.80/0.50M

FFA and IAAF level 1 compliant



Meeting modular  
Ref.13800



Meeting comfort plus single cover  
Ref.13804



Meeting single cover  
Ref.13802



Weather cover  
Ref.13805

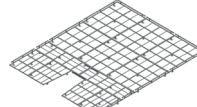

Galvanized platform  
Height 10cm  
Ref.13806

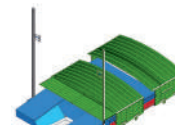

Standard Shed  
Fixed wheels Ref.15600F  
Swivelling wheels Ref.15600

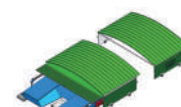

Integral shed  
Fixed wheels Ref.15600FI  
Swivelling wheels Ref.15600I

## ● REVERSIBLE POLE VAULT LANDING SYSTEM ON PLATFORM 7X5X0.80/0.50M

FFA and IAAF level 1 compliant



Reversible meeting modular with platform  
Ref.13835



Weather cover  
Ref.13836

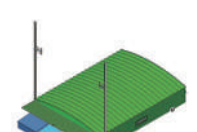

Standard Shed  
Fixed wheels Ref.15514F  
Swivelling wheels Ref.15514

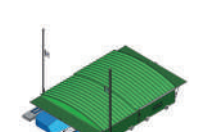

Integral shed  
Fixed wheels Ref.15514FI  
Swivelling wheels Ref.15514I

## ● FEDERAL POLE VAULT LANDING SYSTEM 7.50X5.50X0.80/0.50M

FFA and IAAF level 1 compliant



Federal modular  
Ref.14066

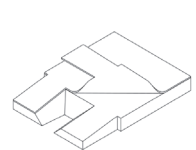

Federal comfort plus single cover  
Ref.14068

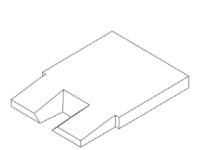

Federal single cover  
Ref.14069



Weather cover  
Ref.14061

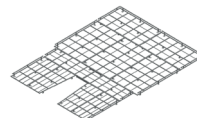

Galvanized platform  
Height 10cm  
Ref.14072

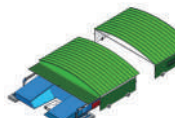

Integral shed  
Fixed wheels Ref.15517FI  
Swivelling wheels Ref.15517I

## ● INTERNATIONAL POLE VAULT LANDING SYSTEM 8X6X0.80/0.50M

FFA and IAAF level 2 compliant



International modular  
Ref.13712

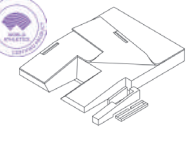

International comfort plus single cover  
Ref.13717

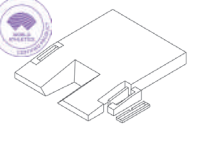

International single cover  
Ref.13713



Weather cover  
Ref.13714

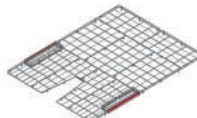

Galvanized platform  
Height 10cm  
Ref.14070



Integral shed  
Fixed wheels Ref.15618FI  
Swivelling wheels Ref.15618I

## ● CONCEPT IV POLE VAULT LANDING SYSTEM 9.50X6.20X0.87/0.37M

FFA and IAAF level 2 compliant



Concept IV modular  
Ref.13739



Weather cover  
Ref.13740

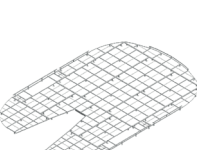

Galvanized platform  
Height 10cm  
Ref.14055



Integral shed  
Fixed wheels Ref.15616FI  
Swivelling wheels Ref.15616I



## ● REVERSIBLE POLE VAULT LANDING SYSTEM ON PLATFORM 7X5X0.80/0.50M

FFA and IAAF level 1 compliant



Reversible meeting modular with platform  
Ref.13835



Weather cover  
Ref.13836

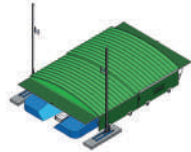

Standard Shed  
Fixed wheels Ref.15514F  
Swivelling wheels Ref.15514

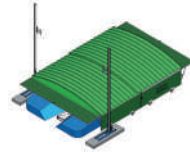

Integral shed  
Fixed wheels Ref.15514FI  
Swivelling wheels Ref.15514I

## ● MEETING DOUBLE FRONT POLE VAULT LANDING SYSTEM 10X5X0.80/0.50M

FFA and IAAF level 1 compliant

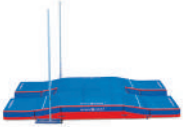

Meeting double front modular  
Ref.19140



Meeting double front comfort plus single cover  
Ref.19142

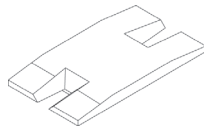

Meeting double-front single cover  
Ref.19143



Weather cover  
Ref.19141

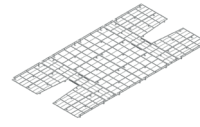

Galvanized platform  
Height 10cm  
Ref.14095

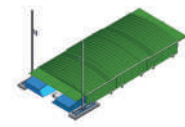

Standard Shed  
Fixed wheels Ref.15610F  
Swivelling wheels Ref.15610

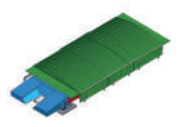

Integral shed  
Fixed wheels Ref.15610FI  
Swivelling wheels Ref.15610I

## ● INTERNATIONAL UP & DOWN DOUBLE FRONT POLE VAULT LANDING SYSTEM 11X6M

FFA and IAAF level 2 compliant



International double-front up&down modular  
11.00x6.00x0.87/0.47m  
Ref.13770

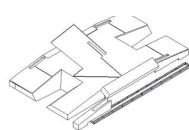

International double-front up&down comfort plus single cover  
11x6x0.87/0.47m  
Ref.13775

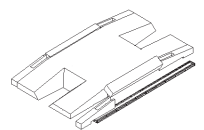

International double-front up&down single cover  
11x6x0.80/0.40m  
Ref.13773



Weather cover  
Ref.13771 Height 0.87m  
Ref.13774 Height 0.80m

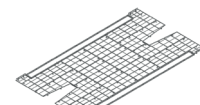

Galvanized platform  
Height 10cm  
Ref.14075

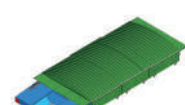

Integral shed  
Fixed wheels Ref.15591FI  
Swivelling wheels Ref.15591I

## ● RAILS



Standard pole vault rails with slider carts  
Ref.14509



Extended pole-vault rails with slider carts  
Ref.14512



Standard rail set in a frame box with sliding cart and cover  
Ref.14534

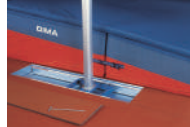

Extended rail set in a frame box with sliding cart and cover  
Ref.14536

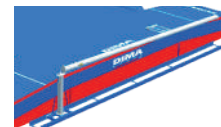

Pole-vault rail with sliding cart to be fixed or embedded - per linear meter  
Ref.14518

## ● POLE VAULT STANDARDS



Stadium pole-vault uprights  
Ref.14220



Basic pole vault uprights  
Ref.14260



Support for foldable pole-vault standards  
Ref.14465

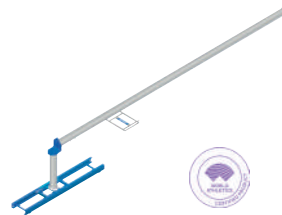

Aluminium IAAF competition foldable pole-vault uprights - without rail - per pair  
Ref.14458



IAAF competition aluminium pole-vault uprights without rail  
Ref.14451

## ● POLE VAULT PROTECTIONS



Standard pole-vault rail base pad  
Ref.14475



Extended pole-vault rail base pad  
Ref.14490



Screw and tie-rod protection pad  
Ref.14459



Cranking handle protection/pad  
Ref.14453



Upright pad/foam protection  
Ref.14454



Foam protection for pole-vault rails per linear meter  
Ref.14456

## ● POLE VAULT STANDARDS ACCESSORIES



Resin cranking handle  
Ref.10246000



Aluminium cranking handle  
Ref.10246001



Multi-positional bracket  
Ref.14451005



Extended bracket  
Ref.14450031



# JUMPING

## VAULT BOX

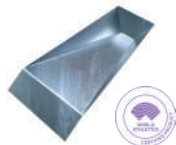

Vault box  
Ref.11120

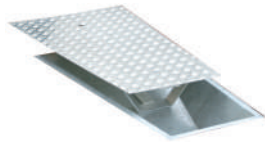

Vault box lid  
Ref.11110

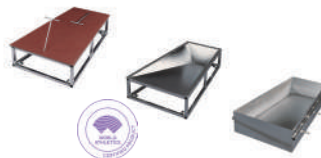

Removable vault box  
Complete system Ref.11130



Movable training vault box  
Ref.11102



Free standing vault box  
Ref.11105

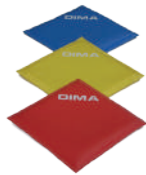

Pole vault mat  
Ref.11107



Foam pole support  
Ref.11104



Fixed pole rack  
Ref.12330



Mobile pole bag rack  
Ref.12331

## POLE VAULT KIT



Pole vault plus athletics pack  
Ref.70130



Crossbar placers - Per pair  
Ref.14460

Mini crossbar placers - Per pair  
Ref.14470



Pole vault athletics pack  
Ref.70140



Basic double front extension  
Ref.17230



Pole-vault upright setting  
indicator board Ref.10785

More details on  
[dimasport.fr](http://dimasport.fr)

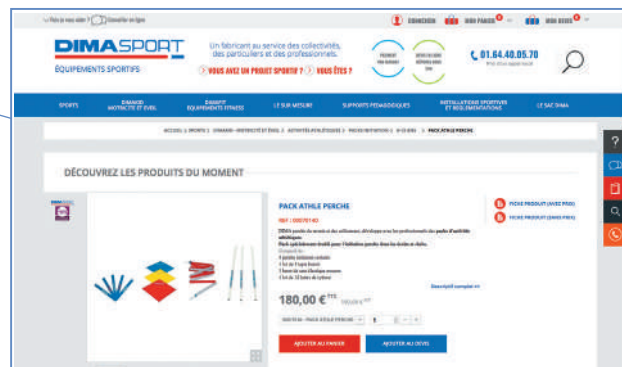

## POLE VAULT ACCESSORIES



Foam elastic crossbar  
Ref.10570



Elastic tape crossbar  
Ref.10580



Elastic roll/bungee cord - 25m  
Ref.10560



Competition pole-vault crossbar  
4.50m Ref.14410



IAAF certified pole-vault crossbar  
4.50m Ref.14411



Competition telescopic height  
gauge with pointer  
Ref.11582



Rolling rack for crossbars  
Ref.14415



Officials' flags red/white  
Per pair - Ref.11300



Officials' flags yellow  
Per pair - Ref.11310



Take-off markers  
Set of 10 Ref.11321



Windsock  
Ref.76000003



Basic chalk bowl  
Ref.21111



Chalk/magnesia - Set of 8 pains  
Ref.2110010



Dima official's clipboard  
Ref.10820



Foam drainage dome  
Ref.14005



Aluminum drainage dome  
Ref.14006



Portable pole rack  
Ref.12333



Pole stacking shed  
Ref.15530



Swivelling wheels for pole  
stacking shed  
Ref.15535





## POLES



Beginners fiberglass pole 2m  
Ref.10080



**NEW**

Pacer One pole

3M35	Weight	Tip
Ref.19512	36kg (80LBS)	21
Ref.19513	41kg (90LBS)	21
Ref.19514	45kg (100LBS)	21
Ref.19515	50kg (110LBS)	21
3M60		
Ref.19521	41kg (90LBS)	21
Ref.19522	45kg (100LBS)	21
Ref.19523	50kg (110LBS)	21
Ref.19524	54kg (120LBS)	21
Ref.19525	59kg (130LBS)	18
4M		
Ref.19532	50kg (110LBS)	18
Ref.19534	54kg (120LBS)	18
Ref.19536	59kg (130LBS)	18



**NEW**

Pacer FXV pole

3M50	Weight	Tip
Ref.15025	45kg	21
Ref.15026	54kg	21
Ref.15027	59kg	16
3M75		
Ref.15002	45kg	21
Ref.15003	54kg	18
Ref.15004	63kg	18
4M		
Ref.15030	50kg	18
Ref.15040	54kg	18
Ref.15050	59kg	18
Ref.15060	63kg	18
Ref.15070	68kg	18
4M25		
Ref.15090	57kg	16
Ref.15100	59kg	16
Ref.15110	61kg	13
Ref.15120	63kg	13
Ref.15130	66kg	13
Ref.15140	68kg	13
Ref.15150	70kg	13
Ref.15160	73kg	13
Ref.15161	75kg	13
Ref.15162	77kg	10
Ref.15163	80kg	10
4M40		
Ref.18334	59kg	13
Ref.18336	61kg	13
Ref.18338	63kg	10
Ref.18340	66kg	10
Ref.18342	68kg	10
Ref.18344	70kg	10
Ref.18346	73kg	10
4M60		
Ref.15180	63kg	10
Ref.15190	66kg	10
Ref.15200	68kg	10
Ref.15210	70kg	10
Ref.15220	73kg	7
Ref.15230	75kg	7
Ref.15240	77kg	10
Ref.15250	80kg	7
Ref.15251	82kg	5
Ref.15253	84kg	5



Dima Lancet fiberglass pole

2M70	Weight
Ref.27024	24kg
Ref.27027	27kg
Ref.27030	30kg
Ref.27033	33kg
Ref.27035	35kg
Ref.27037	37kg
Ref.27041	41kg
Ref.27044	44kg

3M10	Weight
Ref.18000	25kg
Ref.18200	27kg
Ref.18010	30kg
Ref.18210	33kg
Ref.18020	35kg
Ref.18220	37kg
Ref.18230	40kg
Ref.18240	43kg
Ref.18250	45kg
Ref.14950001	Dima Lancet pole tip



**NEW**

Pacer composite pole - Fiberglass

4M15	Poids	Embout
Ref.71501	57kg (125LBS)	18
Ref.71502	59kg (130LBS)	18
Ref.71503	61kg (135LBS)	16
Ref.71504	63kg (140LBS)	16

4M25	Poids	Embout
Ref.71511	59kg (130LBS)	16
Ref.71512	61kg (135LBS)	16
Ref.71513	63kg (140LBS)	16
Ref.71514	66kg (145LBS)	16

4M40	Poids	Embout
Ref.71521	61kg (135LBS)	13
Ref.71522	63kg (140LBS)	13
Ref.71523	66kg (145LBS)	10
Ref.71524	68kg (150LBS)	10

4M60	Poids	Embout
Ref.71600	63kg (140LBS)	13
Ref.71610	66kg (145LBS)	10
Ref.71620	68kg (150LBS)	10
Ref.71630	70kg (155LBS)	10
Ref.71640	73kg (160LBS)	10
Ref.71650	75kg (165LBS)	10
Ref.71660	77kg (170LBS)	10
Ref.71670	80kg (175LBS)	10
Ref.71680	82kg (180LBS)	7
Ref.71690	84kg (185LBS)	7

4M90	Poids	Embout
Ref.70310	73kg (160LBS)	10
Ref.70340	75kg (165LBS)	10
Ref.70370	77kg (170LBS)	10
Ref.70400	80kg (175LBS)	10
Ref.70430	82kg (180LBS)	7
Ref.70450	84kg (185LBS)	7
Ref.70480	86kg (190LBS)	5

5M	Poids	Embout
Ref.71010	77kg (170LBS)	10
Ref.71020	80kg (175LBS)	7
Ref.71070	82kg (180LBS)	7
Ref.71120	84kg (185LBS)	7
Ref.71170	86kg (190LBS)	5
Ref.71171	88kg (195LBS)	5
Ref.71172	91kg (200LBS)	4
Ref.71173	93kg (205LBS)	4
Ref.71174	95kg (210LBS)	4



Pacer pole tip

Référence	Tip
Ref.14932	2
Ref.14934	4
Ref.14935	5
Ref.14937	7
Ref.14940	10
Ref.14943	13
Ref.14946	16
Ref.14948	18
Ref.19600	21



Pole car rack  
Ref.15570



Pole bag

Référence	Length
Ref.15458	3.10 / 3.35 m
Ref.15459	3.50 / 3.75 m
Ref.15460	4.00 / 4.25 m
Ref.15470	4.40 / 4.60 m
Ref.15480	4.80 / 5.00 m
Ref.15455	Customised pole bag
Ref.15490	Padlock security for pole bag
Ref.15491	Rigid sheath for pole bag (per linear meter)

## ● SINGLE COVER HIGH JUMP LANDING SYSTEMS



Single cover high jump landing system

4.50x2.50x0.50m Ref.15980  
5x2.50x0.50m Ref.15990  
5x3x0.50m Ref.15995



Weather cover

4.50x2.50x0.50m Ref.15841  
5x2.50x0.50m Ref.16983  
5x3x0.50m Ref.16615

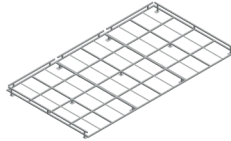

Galvanized platform  
Height 10cm

4.50x2.50m Ref.15845  
5x2.50m Ref.15812  
5x3 m Ref.15847

## ● AIRFOAM HIGH JUMP LANDING SYSTEM



Airfoam high jump landing system

4x2x0.50m Ref.15760  
4.50x2.50x0.50m Ref.15840  
5x3x0.50m Ref.19090



Weather cover

4x2x0.50m Ref.15761  
4.50x2.50x0.50m Ref.15841  
5x3x0.50m Ref.16615

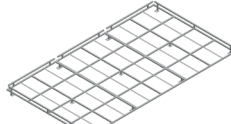

Galvanized platform  
Height 10cm

4x2m Ref.15765  
4.5x2.5m Ref.15845  
5x3m Ref.15847

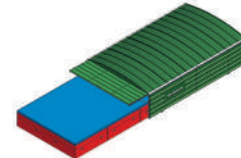

Shed

Fixed wheels Ref.15500F Swivelling wheels Ref.15500  
Fixed wheels Ref.15611F Swivelling wheels Ref.15611

## ● BASIC HIGH JUMP LANDING SYSTEM 5X2.50X0.60M



Basic high jump  
Ref.17200



Weather cover  
Ref.17201



Galvanized platform  
Height 10cm  
Ref.15812



Shed

Fixed wheels Ref.15501F  
Swivelling wheels Ref.15501

## ● CLUB FFA HIGH JUMP LANDING SYSTEM 5X3X0.70M

FFA and IAAF level 1 compliant



Club FFA modular  
Ref.19030

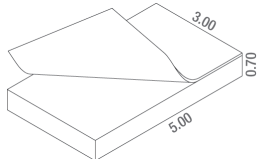

Club FFA Comfort plus single cover  
Ref.19085

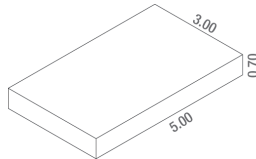

Club FFA single cover  
Ref.19083



Weather cover  
Ref.19031

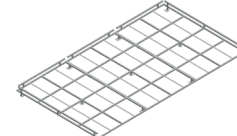

Galvanized platform  
Height 10cm  
Ref.15847

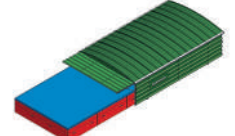

Shed  
Fixed wheels Ref.15611F  
Swivelling wheels Ref.15611



More details on  
[dimasport.fr](http://dimasport.fr)

The screenshot shows the DIMASPORT website interface. At the top, there's a navigation bar with 'SPORTS', 'DIMASPORT', 'EQUIPEMENTS SPORTIFS', and contact information. The main content area displays the product 'MATELAS HAUTEUR CLUB FFA MODULAIRE 5.00 X 3.00 X 0.70M' with a price of 4 660,00 € TTC. The product image shows a blue and red mat with a white frame. The page also includes a 'Description complète' link and buttons for 'AJOUTER AU PANIER' and 'AJOUTER AU DEVIS'.

● **INTERCLUB HIGH JUMP LANDING SYSTEM 6X3X0.70M** FFA and IAAF level 1 compliant 



Interclub modular  
Ref.19060

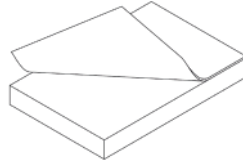

Interclub comfort plus  
single cover  
Ref.19065

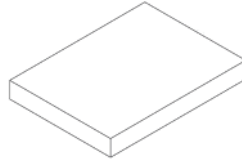

Interclub single  
cover  
Ref.19063



Weather cover  
Ref.19062

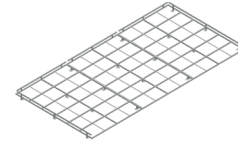

Galvanized platform  
Height 10cm  
Ref.15848

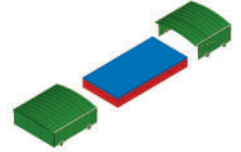

Shed  
Fixed wheels Ref.15516F  
Swivelling wheels Ref.15516

● **CHALLENGER HIGH JUMP LANDING SYSTEM 6X3.25/3X0.70M** FFA and IAAF level 1 compliant 



Challenger modular  
Ref.19170

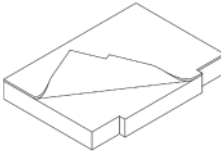

Challenger comfort plus  
single cover  
Ref.19175

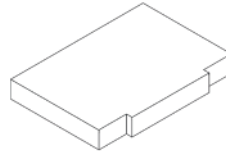

Challenger single  
cover  
Ref.19173



Weather cover  
Ref.19071

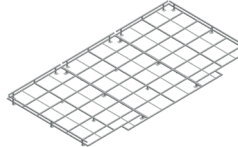

Galvanized platform  
Height 10cm  
Ref.15830

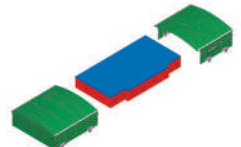

Shed  
Fixed wheels Ref.15516F  
Swivelling wheels Ref.15516

● **INTERNATIONAL HIGH JUMP LANDING SYSTEM 6X4X0.70M** FFA and IAAF level 2 compliant 



International modular  
Ref.19045

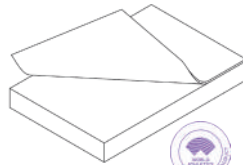

International comfort  
plus single cover  
Ref.19055

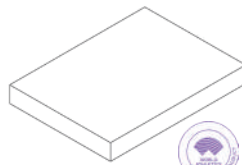

International single  
cover  
Ref.19042



Weather cover  
Ref.19043

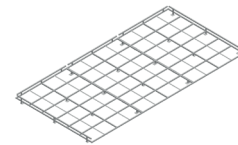

Galvanized platform  
Height 10cm  
Ref.15821

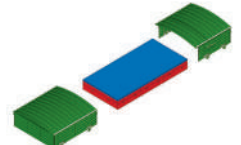

Shed  
Fixed wheels Ref.15608F  
Swivelling wheels Ref.15608

● **CHALLENGER IAAF HIGH JUMP LANDING SYSTEM 6X4.25/4X0.70M** FFA and IAAF level 2 compliant 



IAAF challenger  
modular  
Ref.19112

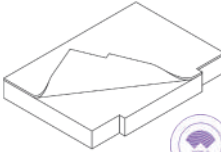

IAAF challenger comfort  
plus single cover  
Ref.19116



Weather cover  
Ref.19113

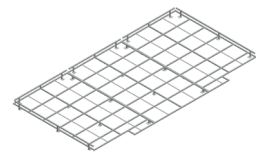

Galvanized platform  
Height 10cm  
Ref.15815

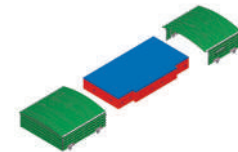

Shed  
Fixed wheels Ref.15619F  
Swivelling wheels Ref.15619

● **GRAND CHAMPIONNAT HIGH JUMP LANDING SYSTEM 7X4.25/4X0.70M** FFA and IAAF level 2 compliant 



Major championship  
modular  
Ref.15690



Major championship  
comfort plus single  
cover  
Ref.15695



Weather cover  
Ref.15691

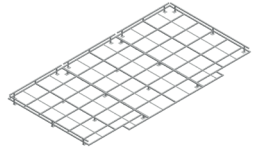

Galvanized platform  
Height 10cm  
Ref.15755

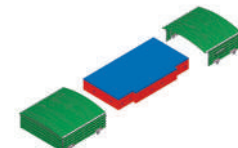

Shed  
Fixed wheels Ref.15518F  
Swivelling wheels Ref.15518

● **CONCEPT III HIGH JUMP LANDING SYSTEM 8X4.25/4X0.70M** FFA and IAAF level 2 compliant 



Concept III modular  
Ref.19076



Weather cover  
Ref.19077

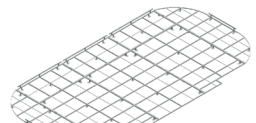

Galvanized platform  
Height 10cm  
Ref.15832

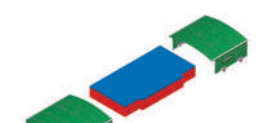

Shed  
Fixed wheels Ref.15519F  
Swivelling wheels Ref.15519

## • HIGH JUMP STANDARDS



School high jump standards  
Ref.14150



Multi-position high jump standards  
Ref.14320



Club high jump standards  
Ref.14310



Club high jump standards with deflector  
Ref.14311



Interclub high jump standards  
Ref.14315



Competition telescopic steel high jump standards  
Ref.14305



IAAF high jump standards with 2 bar rests  
Ref.14300



IAAF high jump standards with 3 bar rests  
Ref.14301



Elite telescopic high jump standards  
Ref.14306



Super elite aluminum high jump standards with cranking handles  
Ref.14307



Grand prix aluminum high jump standards  
Ref.14302



Major championship aluminum high jump standards with cranking handle  
Ref.14303



High jump standard cart/trolley  
Ref.14312



Step ladder - 2 steps  
Ref.10924

## • HIGH JUMP ACCESSORIES



Major competition high jump crossbar 4m  
Ref.14401



Competition high jump crossbar 4m  
Ref.14400



Mini high-jump crossbar placer 110cm  
Ref.14480



Foam elastic crossbar  
Ref.10570



Elastic roll/bungee cord - 25m  
Ref.10560



Foam drainage dome  
Ref.14005



Aluminum drainage dome  
Ref.14006



Competition telescopic high jump height gauge from 0.85 to 3m  
Ref.11581



Aluminium school high jump height gauge marked 2m  
Ref.11541



Aluminium height gauge with sliding marker graduated 2,5m  
Ref.11560



Elastic tape crossbar  
Ref.10580



Rolling Rack For Crossbars  
Ref.14415



Drying surface roller  
Ref.13170

## • MADE TO MEASURE



Replacement cover  
Ref.15860



Airfoam replacement units  
Per cbm - Ref.80000010



Weather cover  
Per sqm - Ref.15862

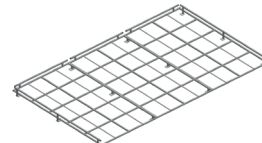

Galvanized platform  
Per sqm - Ref.15881

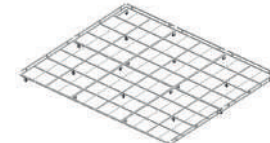

Galvanized platform on castors  
Per sqm - Ref.15891



Spike-proof top pad - 7cm thick  
Per sqm - Ref.15870



Spike-proof top pad - 10cm thick  
Per sqm - Ref.15871

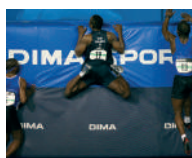

Finish protection pad  
Per sqm - Ref.23030001



Customized printing  
Ref.70000057



Equipment cart with towing bracket  
Ref.10730



Equipment cart with ball-bearing mounted towing bracket  
Ref.10720



Horizontal transportation cart  
2.50x1.22m Ref.22351



Locking platform  
Ref.15885



Vertical transportation cart  
Ref.22352

## ● LONG JUMP



  
Competition take-off board  
Ref.11262



Installation tray for competition take-off board  
Ref.11264



Installation tray for competition take-off board - special renovation  
Ref.11266

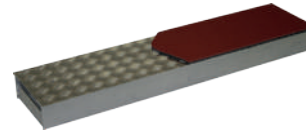

Blanking lid with edges for competition take-off board  
Ref.11272004

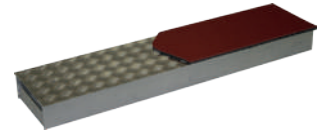

Blanking lid without edges for competition take-off board  
Ref.11272002



Foul board for competition take-off board  
Ref.11262002



Wooden adaptor for competition take-off board  
Ref.11265

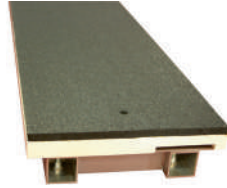

Reversible take-off board  
Ref.11250

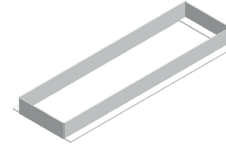

Frame for reversible take-off board  
Ref.11261



Foul board for reversible competition take-off board  
Ref.11260002



Plasticine spatula  
Ref.11285



Plasticine load  
Ref.11280

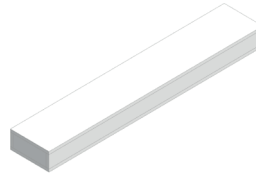

School take-off board  
Ref.11240

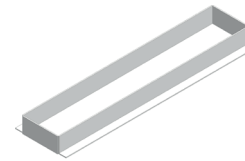

Installation tray for school take-off board  
Ref.11241



Foul board cart  
Ref.12332



Long jump distance indicator boards (5.6.7.8.9) - Set of 5  
Ref.11345



Triple jump distance indicator boards (14.15.16.17.18) - Set of 5  
Ref.11365



Long jump PVC distance indicator board  
Ref.11340



Triple jump PVC distance indicator board  
Ref.11360

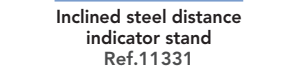

Inclined steel distance indicator stand  
Ref.11331



Vertical steel distance indicator stand  
Ref.11330



Tape skate kit  
Ref.11605



Sand border  
Ref.11380

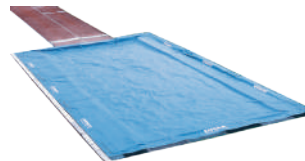

Sand pit cover for long jump and triple jump - Per sqm  
Ref.15863 (with eyelets)  
Ref.15864 (with ballast bags)  
Ref.15865 (with ballast bars)

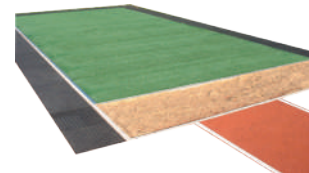

Aluminium sand pit cover for long jump and triple jump  
Ref.11370



Take-off board markers  
Per pair - Ref.11269



Laser optic measuring device for long jump/triple jump  
Ref.11420



Sand pit rake  
Ref.76000005



Sand pit scraper  
Ref.76000006



Sand pit broom  
Ref. 76000007



Sand pit shovel  
Ref.76000004



Rounded wooden jump training box/GPP step  
Ref.10762 120x40x5cm  
Ref.10761 120x40x10cm  
Ref.10760 120x40x20cm



Standard GPP benches / plyo boxes  
Ref.10770 Height 10cm  
Ref.10771 Height 20cm  
Ref.10772 Height 30cm  
Ref.10773 Height 40cm  
Ref.10774 Height 50cm  
Ref.10775 Synthetic-optional



Stacking plyo boxes  
Set of 4 Ref.10777



Trapezoid plyometric boxes / benches  
Set of 3 Ref.10750



Rounded steel bench / plyobox  
Ref.10765

## ● STANDARD POLE VAULT SHED

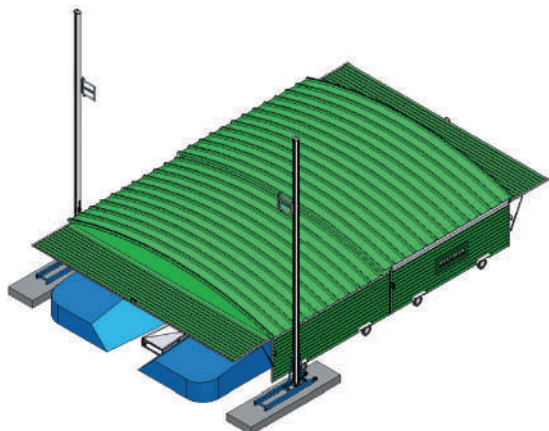

Fixed wheel



Swivelling wheel



Jack-operated

Designation	Landing mat dimensions	Fixed wheels	Swivelling wheels	Characteristics	
Shed for Basic pole vault landing system	5x4.25x0.60m	Ref.15510F	Ref.15510	1 element	1 jack-operated door
Shed for Club pole vault landing system	6.30x5x0.80m	Ref.15506F	Ref.15506	2 elements	1 jack-operated door
Shed for Meeting pole vault landing system	7x5x0.80m	Ref.15600F	Ref.15600	2 elements	1 jack-operated door
Shed for Reversible pole vault landing system	7x5x0.80m	Ref.15514F	Ref.15514	2 elements	2 jack-operated doors
Shed for Federal pole vault landing system	7.50x5.50x0.80m		See Integral Shed		
Shed for International pole vault landing system	8x6x0.87m		See Integral Shed		
Shed for Concept IV pole vault landing system	9.50x6.20x0.87m		See Integral Shed		
Shed for Meeting double front pole vault landing system	10x5x0.80m	Ref.15610F	Ref.15610	3 elements	2 jack-operated doors
Shed for International double front pole vault landing system	11x6x0.87m		See Integral Shed		
Made to measure Shed for pole vault landing system		Ref.15500070	Ref.15500020		

## ● INTEGRAL POLE VAULT SHED

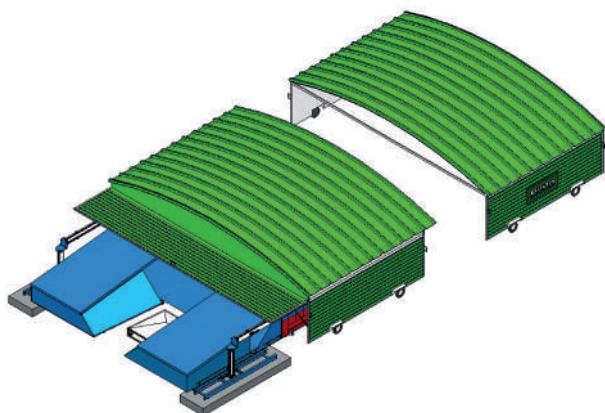

Designation	Landing mat dimensions	Fixed wheels	Swivelling wheels	Characteristics	
Integral Shed for Club pole vault landing system	6.30x5x0.80m	Ref.15506FI	Ref.15506I	2 elements	1 jack-operated door
Integral Shed for Meeting pole vault landing system	7x5x0.80m	Ref.15600FI	Ref.15600I	2 elements	1 jack-operated door
Integral Shed for Reversible pole vault landing system	7x5x0.80m	Ref.15514FI	Ref.15514I	2 elements	2 jack-operated doors
Integral Shed for Federal pole vault landing system	7.50x5.50x0.80m	Ref.15517FI	Ref.15517I	2 elements	1 jack-operated door
Integral Shed for International pole vault landing system	8x6x0.87m	Ref.15618FI	Ref.15618I	2 elements	1 jack-operated door
Integral Shed for Concept IV pole vault landing system	9.50x6.20x0.87m	Ref.15616FI	Ref.15616I	3 elements	1 jack-operated door
Integral Shed for Meeting double front pole vault landing system	10x5x0.80m	Ref.15610FI	Ref.15610I	3 elements	2 jack-operated doors
Integral Shed for International double front pole vault landing system	11x6x0.87m	Ref.15591FI	Ref.15591I	3 elements	2 jack-operated doors
Made to measure integral Shed for pole vault landing system		Ref.15500070	Ref.15500020		

## STANDARD HIGH JUMP SHED



Designation	Landing mat dimensions	Fixed wheels	Swivelling wheels	Characteristics
Shed for EPS high jump landing system	4x2.50x0.50m	Ref.15500F	Ref.15500	1 element
Shed for Basic high jump landing system	5x2.50x0.60m	Ref.15501F	Ref.15501	1 element
Shed for Club high jump landing system	5x3x0.70m	Ref.15611F	Ref.15611	1 element
Shed for Interclub high jump landing system	6x3x0.70m	Ref.15516F	Ref.15516	2 elements
Shed for Challenger high jump landing system	6x3.25/3x0.70 m	Ref.15516F	Ref.15516	2 elements
Shed for International high jump landing system	6x4x0.70m	Ref.15608F	Ref.15608	2 elements
Shed for Challenger IAAF high jump landing system	6x4.25/4x0.70m	Ref.15619F	Ref.15619	2 elements
Shed for Grand Championnat high jump landing system	7x4.25/4x0.70m	Ref.15518F	Ref.15518	2 elements
Shed for Concept III high jump landing system	8x4.25/4x0.77m	Ref.15519F	Ref.15519	2 elements
Made to measure Integral Shed for high jump landing system		Ref.15500060	Ref.15500010	

## POLE STACKING SHED



Swivelling wheels for pole stacking shed Ref.15535

Pole stacking shed Ref.15530



Shed on swivelling wheels for 2 hurdle carts Ref.15550



Shed on swivelling wheels for 3 hurdle carts Ref.15560



Equipment shed with swivelling wheels 5.10x2.35x1.90 m Ref.15520

Equipment shed for fixed ground installation 5.00x2.00x1.70 m Ref.15540

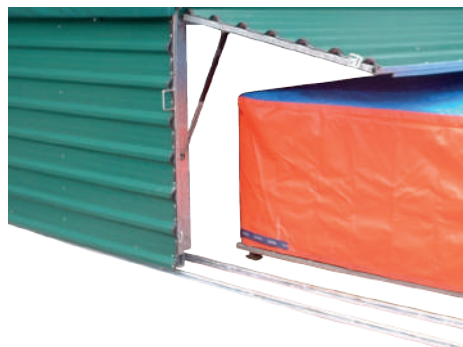

Shed on rail -> On request

# THROWING

## • HAMMER THROWING CAGE

FFA and IAAF compliant



IAAF galvanized steel hammer cage with ground sleeves Ref.13278

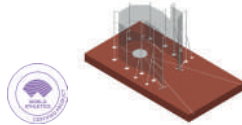

IAAF aluminum hammer cage with galvanized steel doors and ground sleeves Ref.13293

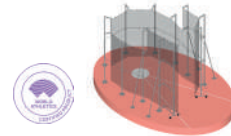

IAAF aluminum hammer cage with ground sleeves Ref.13289



Rolling strips for I.A.A.F. panels - the pair Ref.13341

Galvanized steel hammer cage with foldable brackets (upon request)



Reinforced shot/hammer circle with cross bracing Ref.11160



Shot/hammer circle with cross bracing Ref.11161



Hammer conversion circle Ref.11190

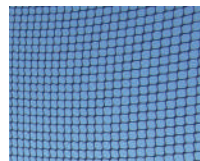

Net  
 Net for hammer cage 24.50 x 7.30 m  
 Exterior net for hammer cage 25.5 x 7.30m  
 Net for hammer cage exit lane and doors 10.30x5.80m  
 Custom-made 5mm polypropylene net - per sqm  
 Custom-made 4mm polypropylene net - per sqm

Ref.30714001  
 Ref.3072822  
 Ref.30714007  
 Ref.30714006  
 Ref.30714005

## • DISCUS THROWING CAGE

FFA and IAAF compliant

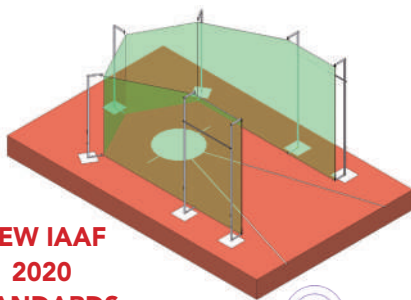

NEW IAAF  
 2020  
 STANDARDS

IAAF galvanized steel discus cage with ground sleeves Ref.13278

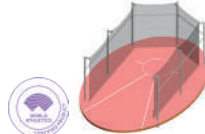

Aluminium discus cage 4.50 m high (above ground) Ref.13271



Portable galvanized steel discus cage Ref.13277



Portable aluminum discus cage Ref.13270



Discus circle with cross bracing Ref.11200



Anti-rebound safety net with supports Ref.13360



Discus circle with cross bracing Ref.11201



Portable discus throwing circle 40mm thick Ref.11400000

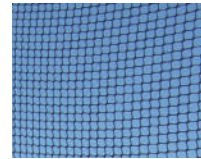

Net  
 Net for discus cage 26 x 5 meters Ref.30714000  
 Custom-made 5mm polypropylene Net - per sqm Ref.30714006  
 Custom-made 4mm polypropylene Net - per sqm Ref.30714005

## • INDOOR SHOT PUT THROWING CAGE

FFA and IAAF compliant

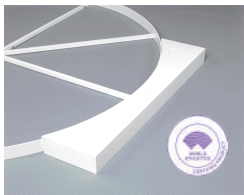

IAAF synthetic shot toeboard Ref.11222



Lacquered pine shot toeboard Ref.11220



Aluminum shot toeboard 80 mm Ref.11221



Shot/hammer circle with cross bracing Ref.11161



Reinforced shot/hammer circle with cross bracing Ref.11160



Surround protection structure with net for shot area - per lm Ref.11400003



Indoor shot put throwing cage dimensions: 20x10x20m - height: 4 meters  
 15x10x15m Ref. 11400015  
 20x10x20m Ref. 11400020



Foam protection pad for indoor shot put throwing cage - per linear meter Ref.11400010



Portable shot put throwing platform with integrated toeboard  
 Height 70mm Ref. 11400001  
 Height 40mm Ref. 11400005



Portable shot put throwing platform with integrated toeboard  
 Height 70mm Ref. 11400070  
 Height 40mm Ref. 11400004



Indoor shot put throwing landing system - 42mm thick  
 Per sqm - Ref.11400002



Shot put throwing landing system 100mm thick  
 Per sqm - Ref.11400006



Portable shot put throwing circle with integrated toeboard 40mm thick Ref.11400007



## • HAMMERS



**Cast iron hammer**

Ref.12915 2kg Ref.12920 3kg  
Ref.12930 4kg Ref.12940 5kg  
Ref.12950 6kg Ref.12960 7.26kg



**Steel hammer**

Ref.12979 2kg Ref.12980 3kg  
Ref.12990 4kg Ref.13000 5kg  
Ref.13035 6kg Ref.13020 7.26kg



**Steel hammer**

Ref.13044 4KG-095mm Ref.13041 4KG-100mm  
Ref.13046 5kg-100mm Ref.13047 6kg-105mm  
Ref.13040 7.26kg-110mm Ref.13042 7.26kg-113mm  
Ref.13043 7.26kg-115mm



**Brass-plated steel hammer**

Ref.13052 4kg-95mm  
Ref.13054 7.26kg-110mm



**Steel training hammer**

Ref.13098 8kg Ref.13099 9kg  
Ref.13100 10kg



**Hammer case**

Ref.13095



**Hammer glove**

Ref.13048 left hand S Ref.13049 left hand M  
Ref.13050 left hand L Ref.13056 right hand S  
Ref.13055 right hand M Ref.13051 right hand L



**Hammer training replacement handle**

Ref.13060 Training  
Ref.13080 Competition



**Spare hammer cable**

Ref.13090 For men 100cm  
Ref.13091 For women 98cm



**Training throwing weights/hammer**

Ref.13101 5.45kg Ref.13102 7.26kg  
Ref.13103 9.08kg Ref.13104 11.34kg  
Ref.13105 15.88kg



**Mobile hammer rack**

Ref.12212



**Rolling circular rack for hammers**

Ref.12210



**Rubber hammer**

Ref.13151 350g Ref.13154 500gr  
Ref.13150 1kg Ref.13152 1.5kg  
Ref.13153 2kg



**Medicine ball with handle**

Ref.21354 1kg Ref.21364 2kg  
Ref.21366 3kg Ref.21374 4kg



**Heavy throwing weight**

Ref.13106 On demand

## • DISCUS



**Rubber discus**

Ref.12340 600gr Ref.12341 800gr  
Ref.12350 1kg Ref.12351 1.25kg  
Ref.12360 1.5kg Ref.12370 1.75kg  
Ref.12380 2kg



**Soft discus**

Ref.12384 Set of 3 - 200gr  
Ref.12383 Set of 3 - 300gr  
Ref.12385 Set of 3 - 500gr



**PVC multi throw discus with handle**

Ref.12386 400gr  
Ref.12387 600gr  
Ref.12388 800gr



**Rubber rings**

Ref.75110 Set of 6



**Throwing ring**

Ref.75121 Set of 3 - 400gr  
Ref.75131 Set of 3 - 600gr

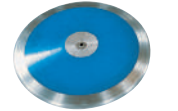

**Plastic challenger discus**

Ref.12000 600gr Ref.12020 800gr  
Ref.12030 1kg Ref.12040 1.25kg  
Ref.12050 1.5kg Ref.12060 1.75kg  
Ref.12080 2kg



**Interclub wooden discus**

Ref.12300 600gr Ref.12301 800gr  
Ref.12302 1kg Ref.12303 1.25kg  
Ref.12304 1.5kg Ref.12305 1.75kg  
Ref.12306 2kg



**Discus**

Ref.12480 600gr Ref.12481 800gr  
Ref.12520 1kg Ref.12251 1.25kg  
Ref.12530 1.5kg Ref.12540 1.75kg  
Ref.12550 2kg



**Obol african competition discus**

Ref.12521 800gr Ref.12522 1kg  
Ref.12523 1.25kg Ref.12524 1.5kg  
Ref.12525 1.75kg Ref.12526 2kg



**Obol plastic competition discus**

Ref.12473 800gr Ref.12474 1kg  
Ref.12475 1.25kg Ref.12476 1.5kg  
Ref.12477 1.75kg Ref.12478 2kg



**Obol mahogany competition discus**

Ref.12561 800gr Ref.12560 1kg  
Ref.12571 1.25kg Ref.12570 1.5kg  
Ref.12580 1.75kg Ref.12590 2kg



**Black super spin discus**

Ref.12145 1kg Ref.12146 1.5kg  
Ref.12147 2kg



**Red super spin II discus**

Ref.12205 1kg  
Ref.12206 : 2kg



**Gold super spin discus**

Ref.12140 1kg Ref.12141 1.5kg  
Ref.12142 1.75kg Ref.12143 2kg



**Yellow super spin discus**

Ref.12148 1kg Ref.12150 1.5kg  
Ref.12151 1.75kg Ref.12152 2kg



**Discus bag**

Ref.12215



**Mobile discus rack**

Ref.12213

## • SHOT PUT



**Indoor rubber shot**

Ref.12779 2kg Ref.12789 3kg  
Ref.12799 4kg Ref.12809 5kg  
Ref.12819 6kg Ref.12829 7.26kg



**Soft rubber shots for schools**

Ref.12904 1kg diam100mm Ref.12905 1.5kg diam100mm  
Ref.12906 2kg diam120mm Ref.12907 3kg diam125mm  
Ref.12908 4kg diam135mm Ref.12909 5kg diam135mm  
Ref.12910 6kg diam140mm Ref.12911 7.26kg diam 140mm



**Weighted ball**

Ref.12840 200gr Ref.12850 500gr  
Ref.12860 1kg Ref.12870 1.5kg  
Ref.12880 2kg Ref.12890 3kg



**Cast iron shots**

Ref.12601 Set of 3-2kg Ref.12611 Set of 3-3kg  
Ref.12621 Set of 3-4kg Ref.12631 Set of 3-5kg Ref.12670 2kg  
Ref.12641 Set of 3-6kg Ref.12651 Set of 3-7.26kg Ref.12700 5kg  
Ref.12680 3kg Ref.12690 4kg  
Ref.12710 6kg Ref.12720 7.26kg



**Steel shot**

Ref.12680 3kg Ref.12690 4kg  
Ref.12710 6kg Ref.12720 7.26kg



**Steel shot**

Ref.12741 4kg diam95mm Ref.12752 5kg diam115mm Ref.12763 7.26kg diam120mm  
Ref.12742 4kg diam100mm Ref.12753 6kg diam115mm Ref.12764 7.26kg diam125mm  
Ref.12744 4kg diam105mm Ref.12754 6kg diam120mm Ref.12770 7.26kg diam128mm  
Ref.12750 4kg diam108mm Ref.12762 7.26kg diam113mm  
Ref.12751 5kg diam110mm Ref.12761 7.26kg diam115mm



**Brass-plated steel shot**

Ref.12772 4kg diam95mm  
Ref.12774 7.26kg diam115mm



**Mobile shot rack**

Ref.12221



**Shot case**

Ref.12230



**Shot put channel**

Ref.12225

# THROWING

## JAVELIN



**Turbo javelin**  
Ref.11720



**Rocket javelin**  
Ref.11726 Set of 3-33cm/125gr  
Ref.11724 Set of 6-33cm/125gr



**Foam javelin**  
Ref.11723 : 90cm/50gr



**Comet ball**  
Ref.11715 6 thrower + 6 ball  
Ref.11716 Set of 6 ball  
Ref.11717 Set of 6 thrower



**Knocken ball**  
Ref.11730 : 200gr Ref.11731 : 400gr  
Ref.11732 : 600gr Ref.11733 : 800gr



**Beginners javelin with plastic tip**  
Ref.14152 Set of 3 300gr  
Ref.14154 Set of 3 400gr  
Ref.14155 Set of 3 500gr  
Ref.14156 Set of 3 600gr



**Aluminium schools javelin**  
Ref.11675 Set of 3 300gr  
Ref.11691 Set of 3 400gr  
Ref.11651 Set of 3 500gr  
Ref.11661 Set of 3 600gr  
Ref.11671 Set of 3 700gr  
Ref.11681 Set of 3 800gr



**Club steel javelin**  
Ref.11851 Set of 3 400gr  
Ref.11852 Set of 3 500gr  
Ref.11853 Set of 3 600gr  
Ref.11854 Set of 3 700gr  
Ref.11855 Set of 3 800gr



**Two-colored competition javelin**  
Ref.11740 400gr  
Ref.11750 500gr  
Ref.11760 600gr  
Ref.11770 700gr  
Ref.11780 800gr



**Javelin/poles carrying tube**  
Ref.12241



**Super obol competition javelin**  
Ref.11960 600gr  
Ref.11970 700gr  
Ref.11980 800gr



**Competition javelin**  
Ref.11751 500gr  
Ref.11761 600gr  
Ref.11771 700gr  
Ref.11781 800gr



**Nemeth universal javelin**  
Ref.82400 400gr  
Ref.82500 500gr  
Ref.82600 600gr  
Ref.82700 700gr  
Ref.82800 800gr



**Nemeth club javelin**  
Ref.82205 600gr 70m  
Ref.82206 600gr 75m  
Ref.82207 800gr 80m  
Ref.82208 800gr 90m



**Nemeth classic javelin**  
Ref.82201 600gr 75m  
Ref.82202 600gr 80m  
Ref.82203 800gr 85m  
Ref.82204 800gr 90m



**Nordic javelin**

Ref.82200 600gr Star-50m  
Ref.82150 600gr Diana-50m  
Ref.82100 600gr Diana-60m  
Ref.82050 600gr Diana-70m  
Ref.80105 800gr Master-60m  
Ref.80100 800gr Master-70m  
Ref.80201 800gr Super Elite-80m  
Ref.80050 800gr Champion  
Ref.80000 800gr Orbit  
Ref.80200 800gr Aiglider

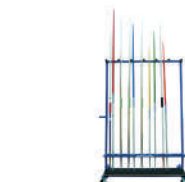

**Javelin display rack**  
Ref.12240



**Round javelin rack**  
Ref.12242



**Javelin carrying case**  
Ref.12010

## THROWING ACCESSORIES



**Long throwing distance marker box**  
Ref.11000



**Short throwing distance marker box**  
Ref.10980



**Long throwing distance field markers**  
Set of 12 Ref.10460



**Short throwing distance field markers**  
Set of 12 Ref.10440



**Sector flags**  
Per pair Ref.11050



**Implement certification kit**  
Ref.11611



**Electronic weighing scale for athletics throwing devices**  
Ref.11631



**Sector line cart**  
Ref.11040



**Plastic sector line**  
Ref.11020



**Fixing staples**  
Set of 100 Ref.11030



**Officials' flags red/white**  
Per pair Ref.11300



**Officials' flags yellow**  
Per pair Ref.11310



**Basic chalk bowl**  
Ref.21111



**Chalk/magnesia**  
Set of 8 Ref.21110010



**Metric tape**  
Ref.10390 20m  
Ref.10395 50m



**Multi-purpose carrying cart**  
Ref.10107



**Target hoops**  
Set of 3 Ref.10190



**Club athletics beginners pack - throwing**  
Ref.70116



**Athletics discovery pack - throwing**  
Ref.70113



**Throwing area**  
Ref.11108

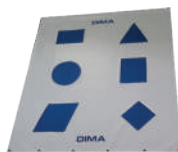

**Baby athle target**  
150x170cm  
Ref.70095



**Target for throwing event landing area**  
- 300X100cm  
Ref.70097



**Vertical target for throwing**  
130x130cm  
Ref.70098

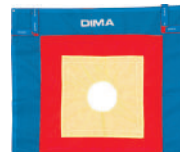

**Target area** 130x130cm  
Ref.70099

# STADIUM ENVIRONMENT

## START/FINISH



Lane marker box  
Per unit Ref.10160



Wooden starter's rostrum  
Ref.10922



Steel starter's rostrum  
Ref.10920



Start clapper board  
Ref.10500



Megaphone range  
Ref.10601 Range 1000m  
Ref.10600 Range 100m



Hand whistle  
Ref.10511



Whistle with lanyard  
Ref.10510 Set of 3



Relay batons  
Ref.10180 Set of 4 aluminium  
Ref.10181 Set of 6 plastic



Timing platform with camera stand  
Ref.10690 With camera stand  
Ref.10691 Clear weather cover - optional



Timers and judges stand  
Eef.10680 8 steps



Timers and judges stand  
Ref.10602 8 seats  
Ref.10622 16 seats



Finish posts to be cast in concrete  
Ref.10860 Per pair



Lap counter with bell on heavy base  
Ref.10840 on heavy base  
Ref.10841 to be cast in concrete



3 place awards stand/stacking plinths  
Ref.10883



3 place steel award's stand  
Ref.10881



3 place wooden award's stand  
Ref.10880



3 place extended wooden award's stand  
Ref.10882



Finish protection pad  
Ref.23030001 Per sqm

## STADIUM EQUIPMENT



Dima official's clipboard  
Ref.10820



Free lane 10cm cone markers  
Ref.10170 Set of 7



Windsock  
Ref.76000003



Free lane flag  
Ref.11050010



Take-off markers  
Ref.11321 Set of 10 multicolors



Section banners  
Ref.9000 50m



Banner fixing post  
Ref.90001 Set of 10



Post for section banner  
Ref.14360



Drying surface roller  
Ref.13170



Chalk/magnesia  
Ref.21111  
Ref.21110010  
Set of 8 Chalk/ magnesia blocks



Step ladder - 2 steps  
Ref.10924



Mat winder with mandrel  
Ref.13190



Training synthetic track roll 6mm - black  
Ref.13172 Roll of 10mx1.25  
Ref.13173 Per linear meter



Training synthetic track roll 12mm - black  
Ref.13162 Roll of 10mx1.25  
Ref.13163 Per linear meter



Mondo competition synthetic track 12mm - Red  
Ref.13161 Roll of 15mx1.22  
Ref.13160 Per linear meter



Transport trolley for a synthetic roll  
Ref.00013195



Grass track line marker  
Ref.11010 Grass track line marker  
Ref.11010001 Paint

## MEASURES



Fiberglass measuring tape  
Ref.11500 10m measuring tape  
Ref.11510 20m measuring tape  
Ref.11520 30m measuring tape  
Ref.11522 50m with handle  
Ref.11525 100m with handle



Steel measuring tape  
Ref.11430 10m measuring tape  
Ref.11440 20m measuring tape  
Ref.11450 30m measuring tape  
Ref.11470 30m with handle  
Ref.11480 50m with handle  
Ref.11490 100m with handle



Distance measuring wheel  
Ref.11640



Pedometer  
Ref.11641



Compact wind gauge  
Ref.11626



Ultrasonic wind gauge  
Ref.11620



Laser distance measuring system  
Ref.11615



Laser optic measuring device for long jump/triple jump  
Ref.11420



Electronic countdown timer  
Ref.11610



Wind speed indicator cart  
Ref.10784 Cart with seat  
Ref.10786 Cart (without seat)



Performance indicator cart  
Ref.10782 Cart with seat  
Ref.10781 Cart (without seat)



Pole-vault upright setting indicator board  
Ref.10785



Portable raised running track unit width 1.22m  
Ref.13420 Running track unit 2.50m with synthetic surfacing  
Ref.13421 Running track unit 2.50m with synthetic surfacing and vault box  
Ref.13422 Running track unit 2.50m with synthetic surfacing and take-off board

# GENERAL PHYSICAL PREPARATION

## ● PLYOMETRIC AND AGILITY



**Training synthetic track roll 6mm - black**  
Ref.10372 Set of 20 straight lines



**Foot speed ladder**  
Ref.10377

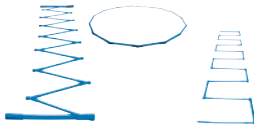

**Agility ladder**  
Ref.10381



**Agility hoop ladder**  
Ref.K5206

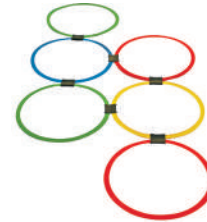

**Hoops ladder**  
Ref.K5205



**Foldable variable height step hurdles 15 & 30cm**  
Ref.10234 Set of 4 with bag (Height 15/30 cm)



**Flat cone marker**  
Ref.10495 diam 20cm height 5cm/ Set of 20  
Ref.10496 diam 20cm height 5cm/ Set of 40  
Ref.10497 diam 30cm height 20cm/Set of 20



**Cone markers carry strap**  
Ref.10498



**Multi-functional flat cone hurdles**  
Ref.10403 Set of 10 haut 15cm  
Ref.10404 Set of 10 haut 20cm



**Multi-functional cone hurdles**  
Ref.10415 Set of 3 (height-7-20-32cm)  
Ref.10416 Set of 3 (height-9-24-39cm)

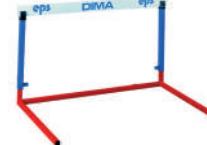

**School hurdle adjustable height**  
Ref.10330 Set of 3 hurdles  
Ref.10336 Set of 6 hurdles



**School mini-hurdle**  
Ref.10230  
Set of 3 mini hurdles



**GPP hurdles**  
Ref.10333 Set of 3 (haut 20-30cm)  
Ref.10334 Set of 3 (haut 40-60cm)



**PVC training hurdle**  
Ref.10331 Set of 3 (adjustable de 40 to 60cm)  
Ref.10337 Set of 3 (adjustable de 40 to 95cm)  
Ref.10332 Set of 6 (adjustable de 40 to 60 cm)



**Aluminium auto return hurdles**  
Ref.10210 Set of 3



**Individual training mat**  
Ref.23951  
100x50x3cm - 50x50x6



**Foam folding hurdle mat**  
Ref.23936 Set of 4  
Height 35cm (unfolded 100x70cm)  
Ref.23941 Set of 4  
Height 50cm (unfolded 100x100cm)  
Ref.23946 Set of 4  
Height 65cm (unfolded 100x130cm)

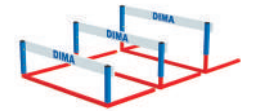

**Baby hurdle**  
Ref.10235 Set of 3  
Ref.10238 Set of 6

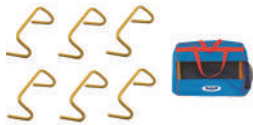

**Step hurdles**  
Ref.10232 Set of 6 Height 15cm  
Ref.102233 Set of 6 Height 30 cm



**Mini obstacles**  
Ref.10345 Set of 8 (50x12x12cm)  
Ref.10346 Set of 8 (50x18x18cm)



**Adjustable GPP foam hurdle**  
Ref.10339 Set of 5



**Dimakid hurdles**  
Ref.10350 Set of 6 (Height 20cm)  
Ref.10355 Set of 6 (Height 40cm)  
Ref.10360 Set of 6 (Mixed set)



**Foam hurdle L100cm x H40cm**  
Ref.10340

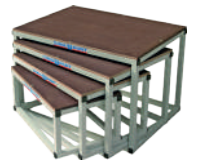

**Stacking plyo boxes**  
Ref.10777 Set of 4



**Cross mat**  
Ref.23940 150x150x1.5cm



**Skipping roper**  
Ref.10370 in PVC with handle length 280cm  
Ref.10369 in cotton without handle length 305cm



**Foam plyometric box**  
Ref.70038 120x120x60cm



**Foam Plyo boxes**  
Ref. FIT01720 60cm Ref. FIT01721 50cm  
Ref. FIT01722 30cm Ref. FIT01723 15cm  
Ref. FIT01724 Set of 4 plyo boxes



**Standard GPP benches / plyo boxes**  
Ref.10770 Height 10cm  
Ref.10771 Height 20cm  
Ref.10772 Height 30cm  
Ref.10773 Height 40cm  
Ref.10774 Height 50cm  
Ref.10775 Synthetic-optional



**Trapezoid plyometric boxes / benches**  
Ref.10750 Set of 3  
(Height 20-30-40cm)



**Rounded steel bench / plyobox**  
Ref.10765 120x75x20cm



**Rounded wooden jump training box/GPP step**  
Ref.10762 Height 5cm  
Ref.10761 Height 10cm  
Ref.10760 Height 20cm



**End-assembling gymnastics track**  
Ref.22360 600x100x5.5cm



**Fully assembling gymnastics school mat**  
Ref.23590 200x100x4cm



**Extra large cylinder foam module diameter 80cm - length 100cm**  
Ref.14330



**Stacking plinths**  
Ref.10883 3 elements



**Exercise / Yoga mat**  
Ref.14945 Set of 10 (140x60x0.80cm)  
Ref.14950 Set of 10 (180x60x0.80cm)  
Ref.14951 Mobile rack (80x60x200cm)  
Ref.14952 Wall support



**Wooden gymnastic bench**  
Ref.Banc2 2m  
Ref.Banc3 3m  
Ref.Banc4 4m

# GENERAL PHYSICAL PREPARATION

## ● TRAINING/DRILLS KITS AND EQUIPMENTS



**Multi-purpose holed marker cones with slotted top**  
Ref.K5010 Set of 4 Height 37 cm  
Ref.K5015 Set of 4 Height 50cm



**PVC cone markers**  
Ref.10485 Set of 12 cones Height 17cm  
Ref.10490 Set of 12 cones Height 37cm



**Cones numbered 5 to 40** Ref.10486  
Set of 8 Height 30cm



**Soft rubber cone markers 18cm**  
Ref.10480 Set of 12 Height 18cm



**Mobility course equipment**  
Ref.K5070



**Multi-purpose Bricks**  
Ref.K5045 Set of 12 bricks  
Ref.K5051 Set of 12 bricks top



**Set of game markers**  
Ref.K5090 :  
20 straight lines  
+ 12 arrows  
+ 4 corners + 12 curves



**Set of markers**  
Ref.K5085 :  
10 round shapes,  
10 square shapes,  
10 triangle shapes



**Set of 10 hands + 10 feet floor markers**  
Ref.K5095



**Vinyl tape**  
Ref.10373 10m  
Ref.10374 20m



**Multi-activity pack**  
Ref.10406 1 pack  
Ref.10407 4 packs with bag



**Nylon pinnies**  
Ref.HOCK650 (6 yellows + 6 red)  
Ref.HOCK651 (6 blue + 6 green)



**Flag football/rugby belt**  
Ref.K5056  
Set of 5 belt



**Flat hoops**  
Ref.K5020 diam 35cm per unit  
Ref.K5022 diam 50cm per unit  
Ref.K5025 diam 60cm per unit  
Ref.K5026 diam 70cm per unit

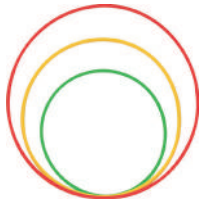

**Hula hoops**  
Ref.10196 diam 50cm per unit  
Ref.10197 diam 75cm per unit



**Bag for hoops**  
Ref.SC67 for hoops of diam 35-50cm  
Ref.SC68 for hoops of diam 60-70 cm

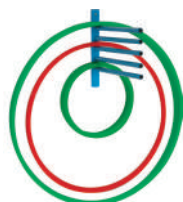

**Hoop wall bracket**  
Ref.10198



**Rotating clips**  
Ref.K5040 Rotating clips for 25mm diameter poles + flat hoops  
Ref.K5041 Rotating clips for 25mm diameter poles + hoops  
Ref.K5042 Rotating clips for 25mm diameter pole + pole

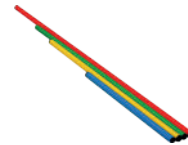

**Pole diameter 25mm**  
Ref.K5029 Set of 8 pole 60 cm  
Ref.K5030 Set of 8 pole 100 cm  
Ref.K5035 Set of 8 pole 120 cm  
Ref.K5036 Set of 8 pole 160 cm



**Plastic base to be filled**  
Ref.10195 Per pair



**Rounder base**  
Ref.10192 Per pair



**Multi-purpose base**  
Ref.10191



**Target hoops**  
Ref.10190  
Set of 3



**Multi-discovery kit**  
Ref.K5075



**Multi-function hurdles**  
Ref.10400 Set of 5 with bag



**Slalom poles with plastic spikes**  
Ref.K5037 Set of 12 Length 150cm



**Basic kit**  
Ref.PACK0001  
6 step hurdles - Height 15cm  
12 flat cones - Height 5cm  
1 foot speed ladder - 6m  
1 storage bag



**Fundamentals kit**  
Ref.PACK0002  
6 step hurdles - Height 15cm  
12 flat cones - Height 5cm  
12 training cones - Height 28cm  
1 foot speed ladder - 6m  
1 speed chute - Diameter 120cm  
1 storage bag



**Plus kit**  
Ref.PACK0003  
2 set of 3 step hurdles  
Heights 15cm, 28cm, 32cm  
12 training cones - Height 28cm  
1 speed ladder - Length 6m  
1 speed chute - Diameter 120cm  
1 storage bag



**Training kit**  
Ref.PACK0004  
1 agility ladder - Length 6m  
8 round base cones - Height 28cm  
10 step hurdles with carry strap  
Height 15cm  
1 resistance belt  
1 storage bag



**Eco kit**  
Ref.PACK0005  
1 agility ladder - Length 6m  
12 flat cones - Height 5cm  
1 foot speed ladder - 6m  
1 speed chute - Diameter 120cm  
1 storage bag



**Fun kit**  
Ref.PACK0006  
6 step hurdles - Height 15cm  
1 agility ladder - Length 6m  
10 flat cones - Height 5cm  
10 training cones - Height 22cm  
1 storage bag



**Mobile storage rack 1 door**  
Ref.70040 dim 55x60x94cm  
Ref.70041 dim 100x65x94cm



**Mobile storage locker 1 door**  
Ref.SC109 dim 100x57x112cm  
Ref.SC110 dim 80x57x157cm



**Foldable ball carrying cart**  
Ref.SC20



**Ball carrying rack cart 156x54x143cm**  
Ref.SC100



**Multi-purpose carrying cart**  
Ref.10107 dim 105x85x105cm



**Vertical rack for medicine balls**  
Ref.SC101

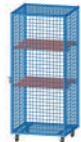

**Mobile equipment storage cupboard 1 door**  
Ref.SC111  
1 door - 2 shelves (84x72x188cm)

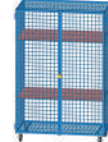

**Mobile equipment storage cupboard 2 doors**  
Ref.SC112  
2 doors - 2 shelves (120x70x183cm)

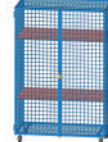

**Mobile equipment storage cupboard 2 doors**  
Ref.SC115  
2 doors - 2 shelves (150x54x157cm)



**Mobile equipment storage cupboard 2 doors**  
Ref.SC113  
2 doors - 2 shelves (150x54x97cm)



**Mobile equipment storage cupboard 4 doors**  
Ref.SC114  
4 doors - 4 sections (150x54x103cm)

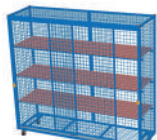

**Mobile equipment storage cupboard with sliding doors**  
Ref.SC116  
dim 201x65x188cm



**Dima carrying bag in spike-proof fabric**  
Ref.SC60  
dim 90x35x35xcm



**Dima carrying bag**  
Ref.SC61  
dim 90x35x35cm



**Dima extra-large carrying bag**  
Ref.10830  
dim 100x60x70cm

# GENERAL PHYSICAL PREPARATION

## STRENGTH EQUIPMENT

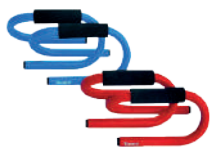

Push-up bars  
Ref.70060 Per pair



Performance push-up bars  
Ref.70065 Per pair



Basic wall bars  
Ref.ESPA1 240x90cm



Double section wall bars  
Ref.ESPA2 250x168cm



Traction bar for wall bars  
Ref.ESPAB



Medicine ball  
Ref.21300 1kg per unit  
Ref.21310 1.5kg per unit  
Ref.21320 2kg per unit  
Ref.21330 3kg per unit  
Ref.21340 4kg per unit  
Ref.21350 5kg per unit



Medicine ball support belt  
Ref.21370



TRX  
Ref.FIT03606



Ab wheel  
Ref.FIT03605



Climbing rope 6M  
Ref.FIT03600



Medicine ball with handle  
Ref.21354 1kg per unit  
Ref.21364 2kg per unit  
Ref.21366 3kg per unit  
Ref.21374 4kg per unit



Dual handle medicine ball  
Ref.21206 6kg per unit  
Ref.21207 7kg per unit  
Ref.21208 8kg per unit



Wall ball  
Ref.FIT03530 4kg  
Ref.FIT03531 6kg  
Ref.FIT03532 8kg  
Ref.FIT03533 10kg



Vertical rack for medicine balls  
Ref.SC101



Kettlebell Per unit  
Ref.21404 4kg  
Ref.21406 6kg  
Ref.21408 8kg  
Ref.21412 12kg  
Ref.21416 16kg  
Ref.21424 24kg  
Ref.21432 32kg



Comfort wrist/ankle weight  
Ref.70034 500gr  
Ref.70028 1kg  
Ref.70022 1.5kg  
Ref.70023 2kg



Weighted glove 500g each  
Ref.70031 Per pair



Dima weighted vest  
Ref.70051 Size M (0 to 10 kg)  
Ref.70052 Size L (0 to 10 kg)



Elastiband  
Ref.70048 10kg  
Ref.70050 15kg  
Ref.70049 20kg



Weighted vest  
Ref.70055 (0 to 10 kg)



Resistance belt with handle  
Ref.70036



Jumping resistance belt  
Ref.70037



Resistance cord with handles  
Ref.70035



Ankle weights  
Per pair - Ref.70030



Ankle resistance straps  
Ref.70032 Per pair



Resistance belt (standalone)  
Ref.70010 Size M  
Ref.70012 Size XL



Elastic roll  
Ref.10560  
bungee cord - 25m  
(diam 6mm)



Dual resistance trainer  
Ref.70011  
(2 belt+12.5 ml parablond tube)



Resistance / speed cord  
Ref.9ATEL004 12.5ml



Gym / swiss ball  
Ref.10367 diam 55cm  
Ref.10366 diam 65cm  
Ref.10368 diam 75cm



Stand for gym ball  
Ref.10365



Resistance speed chute  
Ref.50001 Size S (100cm)  
Ref.50002 Size M (120cm)  
Ref.50003 Size L (140 cm)



Power sled  
Ref.70015

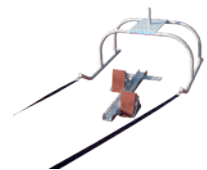

Special start power sled départ  
Ref.70016



Dimafit power sled  
Ref.FIT01730



Free-standing high bar  
Ref.20161



Free-standing parallel bars  
Ref.24151

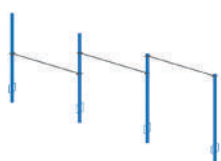

High bars without cables  
Ref.70085 1 rail  
Ref.70086 2 rails  
Ref.70087 3 rails



Pyramid wooden gymnastic vaulting box  
Ref.22326 with rollers



Wooden gymnastic vaulting box  
Ref.22325 with rollers



ABMAT  
Ref.FIT02601 Black  
Ref.FIT02603 Red  
Ref.FIT02604 Rose



HSPU mat - Foldable in 4  
Ref.FIT02621 100x50x3cm  
Ref.FIT02630 100x67x3cm



Gymnastic rings  
Ref.FIT03610  
Diam 28mm/length. 6m



Wooden gymnastic bench  
Ref.BANC2 200x24x31cm  
Ref.BANC3 300x24x31cm  
Ref.BANC4 400x24x31cm



Utility bench  
Ref.FIT01400  
130x35x50cm



Dropping mats  
Ref. FIT26300 80 X 66 X 26 CM  
Ref. FIT26303 80 X 50 X 16 CM



Battle rope  
Ref.FIT03602



Foam Plyo boxes  
Ref. FIT01720 60cm  
Ref. FIT01722 30cm  
Ref. FIT01724 Set of 4 plyo boxes  
Ref. FIT01721 50cm  
Ref. FIT01723 15cm



# GENERAL PHYSICAL PREPARATION

## WEIGHTLIFTING, RACKS AND MOBILITY



**Olympic bar**  
 Ref.FIT03303 15Kg Capacity 300kg  
 Ref.FIT03302 15Kg Capacity 450kg  
 Ref.FIT03301 20Kg Capacity 450kg  
 Ref.FIT03300 20Kg Capacity 800kg



**Bar holder**  
 Ref.FIT01901 (10 bars)

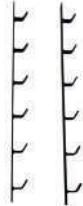

**Wall bar holder**  
 Ref.FIT01900 (6 bars)



**Black bumper plates**  
 Ref.FIT03320 5kg Per pair  
 Ref.FIT03321 10kg Per pair  
 Ref.FIT03322 15kg Per pair  
 Ref.FIT03323 20kg Per pair  
 Ref.FIT03324 25kg Per pair



**Fractional plates**  
 Ref.FIT03325 1kg  
 Ref.FIT03326 2.5kg



**Vertical plate tree**  
 Ref.FIT01903



**Spring collars**  
 Ref.FIT03360 Per pair



**Sandbag with filler**  
 Ref.FIT02570 up to 10kg  
 Ref.FIT02571 up to 20kg  
 Ref.FIT02574 up to 25kg  
 Ref.FIT02572 up to 40kg



**Bumper plates stacker**  
 Ref.FIT01902



**Storage rack for dumbbells**  
 Ref.FIT01904 60x162x82cm



**Dumbbells**  
 Ref.FIT03501 2kg    Ref.FIT03502 4kg    Ref.FIT03503 6kg  
 Ref.FIT03504 8kg    Ref.FIT03505 10kg    Ref.FIT03506 15kg  
 Ref.FIT03507 20kg    Ref.FIT03508 25kg    Ref.FIT03509 30kg  
 Ref.FIT03510 35kg    Ref.FIT03511 40kg    Ref.FIT03512 45kg  
 Ref.FIT03513 50kg



**Pull-up bar 1m10**  
 Ref.FIT01245 diam 30mm



**Pull-up system**  
 Ref.FIT01100 60x130x60cm



**Pro pull up system**  
 Ref.FIT01101 84x135x83cm



**Pull-up system wall or ceiling mounts**  
 Ref.FIT01110 60x130x60cm

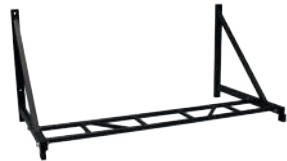

**Multi grips pull-up bar**  
 Ref.FIT01150 60x130x60cm



**Premium squat cage**  
 Ref.70082



**Sloping press**  
 Ref.70081



**Full body workout station**  
 Ref.70080



**Basic squat stand**  
 Ref.FIT01210 186x80cm



**Squat stand**  
 Ref.FIT01201 120x120x240cm



**Yoke**  
 Ref.FIT01440



**Power rack**  
 Ref.FIT01202 170x120x240cm



**Single wall mount rig**  
 Ref.FIT01226 166x120x275cm



**Classical rig**  
 Ref.FIT01220 172x290x275cm



**Wall mount rig**  
 Ref.FIT01225 166x290x275cm



**J-cups**  
 Ref.FIT01270



**Safety spotter arms**  
 Ref.FIT01271



**Dips station**  
 Ref.FIT01275



**Wall ball target**  
 Ref.FIT01284



**Plate storage pin**  
 Ref.FIT01273



**Massage stick**  
 Ref.FIT03861



**Foam roller**  
 Ref.FIT03860 Red  
 Ref.FIT03862 Black  
 Ref.FIT03863 Purple



**Balance board/wobble board**  
 diameter 35 cm height : 8cm  
 Ref.KBG2110



**Fitness cushion pad**  
 Ref.FIT03830



**Bosu balance trainer**  
 Ref.FIT03850

## ATHLETICS PACKS



Athletics discovery pack - Running  
Ref.70231



Athletics discovery pack - Jumping  
Ref.70211



Athletics discovery pack - Multi-game  
Ref.70241



Complete stadiumkit  
Ref.75200  
Stadium kit plus formula  
Ref.75210



Club athletics beginners pack  
Ref.70107



Club athletics beginners pack - throwing  
Ref.70116



Club athletics beginners pack - running  
Ref.70118



Athletics discovery pack - throwing  
Ref.70113



Athletics discovery pack - jumping  
Ref.70114



Athletics discovery pack - running  
Ref.70117



Athletics discovery pack - multidiscipline  
Ref.70115

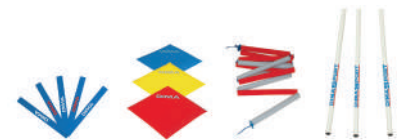

Pole vault athletics pack  
Ref.70140



Pole vault plus athletics pack  
Ref.70130



Foldable long jump mat  
Ref.30231 200x100x20/4cm  
Ref.30230 400x200x30/4cm



5-step foam stairs for long jump  
Ref.30220 300x150x100cm



Take-off mat  
Ref.23900 250x100x3cm



## ANIM'ATHLE EQUIPMENT



**Multi-functional cone hurdles**  
Ref.10415 Set of 3  
(Height 7,20,32,cm)  
Ref.10416 Set of 3  
(adjustable 9,24,39 cm)



**Baby trampoline**  
Ref.K3075 155x115x32cm



**Foam javelin**  
Ref.11723 L'unité



**Rubber rings**  
Ref.75110 Set of 6



**Flat cone marker**  
Ref.10495 diam 20cm  
Height 5cm Set of 20  
Ref.10496 diam 20cm  
Height 5cm Set of 40  
Ref.10497 diam 30cm  
Height 20cm Set of 20



**Gymnastics mat**  
200x100x4cm  
Ref.23510



**Multi-functional flat cone hurdles**  
Ref.10403 Set of 10 Height 5cm  
Ref.10404 Set of 10 Height 20cm



**Throwing ring**  
Ref.75121 Set of 3 400gr  
Ref.75131 Set of 3 600gr



**Wooden gymnastic bench**  
Ref.banc2 2m  
Ref.banc3 3m  
Ref.banc4 4m



**Multi-purpose holed marker cones with slotted top**  
Ref.K5010 Set of 4-4 to 37cm  
Ref.K5015 Set of 4-4 to 50cm



**Training markers**  
Ref.10372 Set of 20



**Rubber hammer**  
Ref.13151 350gr  
Ref.13154 500gr  
Ref.13150 1kg  
Ref.13152 1.5kg  
Ref.13153 2kg



**Soft rubber cone markers 18cm**  
Ref.10480 Set of 12



**Foldable variable height step hurdles 15 & 30cm**  
Ref.10234 Set of 6  
5 Height 15-30cm



**Foam folding hurdle mat**  
Ref.23936 Set of 4 hurdles  
Height 35cm  
Ref.23940 Set of 4 hurdles  
Height 50cm



**Rocket javelin**  
Ref.11726 Set of 3  
Ref.11724 Set of 6



**Metric tape**  
Ref.10390 Bande de 20m  
Ref.10395 Bande de 50m



**Plastic relay baton**  
Ref.10181  
Set of 6



**Beginners fiberglass pole 2m**  
Ref.10080



**Foam pole support**  
Ref.11104



**Landing mattress 300x200x20cm**  
Ref.23050



**Plastic base to be filled**  
Ref.10195 Per pair



**Medicine ball**  
Ref.21300 1kg per unit  
Ref.21310 1.5kg per unit  
Ref.21320 2kg per unit  
Ref.21340 3kg per unit  
Ref.21350 5kg per unit

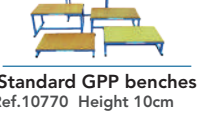

**Standard GPP benches**  
Ref.10770 Height 10cm  
Ref.10771 Height 20cm  
Ref.10772 Height 30cm  
Ref.10773 Height 40cm  
Ref.10774 Height 50cm  
Ref.10775 Synthetic optional



**Pole diameter 25mm**  
Ref.K5029 Set of 8 pole Length 60 cm  
Ref.K5030 Set of 8 pole Length 100 cm  
Ref.K5035 Set of 8 pole Length 120 cm  
Ref.K5036 Set of 8 pole Length 160 cm



**Multi-functional stopwatch**  
Ref.15521



**Multi-position high jump standards**  
Ref.14320

## BABY ATHLE EQUIPMENT



**Cross mat 150x150x1.5cm**  
Ref.23940



**Foam gymnastic beam**  
Ref.24035 2m  
Ref.24030 3m



**Gymnastic low beam**  
Ref.21640 Length 3.60m  
Ref.21650 Length 5.00m



**Summer skis for children**  
Ref.KBG2108 For 2 children  
Ref.KBG2148 For 3 children



**Soft bean bags 12x12cm**  
Set of 6  
Ref.JONGL185



**Tactile discs mobility course (10 pieces)**  
Ref.KBG2117



**Hemisphere stilts**  
Set of 3  
Ref.KBG2119



**3 level platform foam module 160x60x100cm**  
Ref.22321



**Mini obstacles**  
Ref.10345 50x12x12cm  
Ref.10346 50x18x18cm



**Straight line floor markers 34 x 7.5cm** Set of 6  
Ref.K5061



**Ball toss frame set**  
Ref.K5135



**Multicolour plastic bowling set (6 skittles + 2 balls)**  
Ref.K5058



**River stones Set of 6**  
Ref.KBG2120



**Juggling scarves**  
Ref.JONGL190  
Set of 4 (40x40cm)  
Ref.KBG15382  
Set of 6 (68x68cm)



**Dimahop - Set of 2 (1 red & 1 yellow)**  
Ref.KB028407



**Tug of war rope**  
Length 10 m  
Ref.K5057



**Target diameter 150cm and 6 velcro balls**  
Ref.70096



**Vertical target for throwing 130x130cm**  
Ref.70098



**Target for throwing event landing area 300x100cm**  
Ref.70097



**Baby athle target 150x170cm**  
Ref.70095



**Balance board/wobble board diameter 35 cm height : 8cm**  
Ref.KBG2110



**Target hoops**  
Ref.10190



**Flat hoops**  
Ref.K5020 diam 35cm  
Ref.K5022 diam 50cm  
Ref.K5025 diam 60cm  
Ref.K5026 diam 70cm



**Square poly spots**  
Set of 12 in a polybag  
Ref.K5059



**Juggling ball (diam 20 cm) Set of 12**  
Ref.KBG15293



**Beanbag juggling ball**  
Ref.JONGL170  
diam 62mm Set of 3  
Ref.JONGL180  
diam 80mm Set of 3  
Ref.KBGS133  
diam 60mm Set of 12





**Seesaw**  
Ref.KBG2169





**Foam springboard 120x60x25cm**  
Ref.22105

## Equipment required to equip an outdoor stadium

	Page	Régional	National / International
<b>RUNNING</b>			
Lane markers	19	8	8 or 16
Starter's rostrum	19	1	1 to 3
Starting-blocks	4	6 to 8 (+2)	16 (+3)
Starting-blocks cart	4	1	1 or 2
Hurdles	5	65 to 90	90 to 130
Replacement gateboards	5	10	20
30 hurdle cart	5	2 to 3	3
8 hurdle cart	5	10	12 to 15
Steeplechase hurdle	5	1	1
Steeplechase hurdle cart	5		1
Judges' stand	19	1 or 2	1 or 2
Timers' stand	19	1	1 or 2
Lap counter + bell	19	1	1
Finishing posts (2)	19	1	1
Free lane flag	19	1	1
Free lane markers (set of 7)	19	1	1
Relay Batons (set of 4)	4	3 to 4	3 to 4
Cone marker - 20cm	21	60	60
<b>JUMPING</b>			
High jump landing system + Weather cover	10-11	1 (5 x 3m)	1 or 2 (6 x 4m)
Platform (for landing areas durability)	10-11	1	1 or 2
High jump shed (security)	10-11	1	1 or 2
High jump standards (2)	12	1	1 or 2
High jump elastic crossbar	12	1	1 or 2
High jump crossbar 4.00m	12	4	4 to 12
High jump height gauge	12	1	1 or 2
Stempladder	12		2 or 4
Platform (for landing area durability)	6-7	1 (7 x 5m)	1 or 2 (8 x 6m)
Pole vault landing system + Weather cover	6-7	1	1 or 2
Pole vault shed (security)	6-7	1	1 or 2
Pole vault standards (2)	7	1	1 or 2
Rails for Pole vault standards (2)	7	1	1 or 2
Pole vault standard uprights pad	7	1	1 or 2
Pole vault standard base pad	7	1	1 or 2
Pole vault bag rack	8		1 or 2
Pole vault height gauge	8	1	1 or 2
Crossbar placer (2)	8	1	1 or 2
Pole vault Crossbar 4.50m	8	4	4 to 12
Pole vault uprights adjustment indicator cart	8		1 or 2
Poles - upon request	9		
<b>LONG/TRIPLE JUMP</b>			
Take-off board	13	6	6 to 8
Plasticine board	13	8	10 to 12
Plasticine strips	13	6	6 to 8
Take-off board markers (2)	13		2
Long jump distance markers	13	1	2
Triple jump distance markers	13	1	2
Pit rake, broom, scraper (set)	13	2	2
10m Steel measuring tape	19	2	2
20m Steel measuring tape	19	2	2
Plasticine boards cart	13		2
Sand pit cover (cleanliness)	13		2 to 4

	Page	Régional	National / International
<b>THROWING</b>			
Hammer Cage (mixed)	16	1	1
Hammer conversion circle	16	according to config.	
Rolling Strips for IAAF panels	16		1
Hammer cart	17	1	1
Discus cart	17	1	1
Shot put cart	17	1	1
Javelin cart	18	1	1
Discus cage	16		1
Anti-rebound net	16		1
Shot put toeboard	16	1	2
Shot put channel	17		1 or 2
Short throwing distance marker box	18		2 sets of 10
Long throwing distance marker box	18		2 sets of 10
Short Throwing distance field markers (set of 12)	18	2	2
Long throwing distance field markers (set of 12)	18	2	2
50m plastic sector line (boundary)	18	6	8
Sector line cart	18		4
Fixing Staples (set of 100)	18	1	2
Free Lane Flag (2)	18		3
100m Steel measuring tape	19	1	1
30m Steel measuring tape	19	2	2
Hammer spare wires	17	5	
Throwing Equipment certification unit	18		1
Throwing equipment upon request	17-18	3 of each	3 of each
<b>STADIUM ENVIRONMENT</b>			
Sector flags + fixing pegs	19		200m
Officials flags white/red (2)	18	10	10
Officials flags yellow (2)	18	10	10
Officials clipbord	19	10	20
Performance indicator cart	19	5	8 to 10
Electronic countdown clock	19		6 to 8
Wind indicator	19	3	4 to 6
Wind gauge	19	2	2 to 4
Wind sock	19	5	6 to 8
Chalk bowl (+ chalk blocks)	19	2	2 to 4
Take-off markers (set of 10)	19	5	6 to 8
Crossbar cart	8-12		2
Mini steeplechase barriers	5		1
Awards' stand	19	1	1
Equipment cart	12-21	1	2
Measuring wheel	19		1
<b>EQUIPMENT TO BE FIXED DOWN</b>			
Take-off board foundation tray	13	6	6 to 8
Take-off board lid	13	6	6 to 8
Vault box	8	1	2
Vault box lid	8	1	2
Shot put /hammer circle with cross bracing	16	2	3
Discus circle with cross bracing	16	1	2
Hammer cage ground sleeves	16	1	1
Discus cage ground sleeves	16	1	1
Finish post ground sleeves	19	1	1
Water jump hurdle ground sleeves	5	1	1
<b>SCHOOLS AND ATHLETICS ORGANISATIONS EQUIPMENT</b>		20-21-24-25	

# Equipment required to equip an indoor stadium

	Page	Régional	National / International
<b>RUNNING</b>			
Lane markers	19	6 to 8	6 to 16
Starter's rostrum	19	1	1 or 2
Starting-blocks	4	6 to 8 (+2)	8 (+2)
Starting-blocks cart	4	1	1
Hurdles	5	30 to 40 (+5)	30 to 40 (+5)
Replacement gateboards	5	10	20
8 hurdle cart	5	5	5
Judges stand	19	1 or 2	1 or 2
Finishing posts (2)	19	2	2
Lap counter + bell	19	1	1
Sector flag	19	1	1
Free lane markers (set of 7)	19	1	1
Relay Batons (set of 4)	4	3	3
Finish protection pad 	12	1	1
<b>JUMPING</b>			
High jump landing systems	10-11	1 (5 x 3m)	1 (6 x 4m)
High jump standards (2)	10-11	1	1
High jump elastic crossbar	12	1	1
Crossbar 4.00m	12	4	6 to 8
High jump height gauge	12	1	1
3 rung step ladder	12		2
Pole vault landing standards	6-7	1 (7 x 5m)	1 (8 x 6m)
Pole vault standards (2)	7	1	1
Rails for pole vault standards (2)	7	1	1
Pole vault standards protection pad (2)	7	1	1
Pole vault standards base pad (2)	7	1	1
Pole vault bag rack	8		1
Pole vault height gauge	8	1	1
Cross bar placer (2)	8	1	1
Cross bar 4.50m	8	4	6 to 8
Pole vault standards adjustment display panel	8		1
Poles - upon request	9		
<b>LONG/TRIPLE JUMP</b>			
Take-off board	13	6	6 to 8
Plasticine board	13	8	10 to 12
Plasticine strips	13	6	6 to 8
Plasticine board cart	13		2
Take-off board markers (2)	13		2
Long jump distance markers	13	1	2
Triple jump distance markers	13	1	2
10m Steel measuring tape	19	2	2
20m Steel measuring tape	19	2	2
Pit rake, broom, scraper (set)	13	1	1

	Page	Régional	National / International
<b>THROWING</b>			
Indoor shot put circle with toeboard	16	1	1
Shot put throwing cage (height 4m)	16	1	1
Shot put landing area (mat)	16	150 to 200m <sup>2</sup>	150 to 200m <sup>2</sup>
Shot put cart	17	1	1
Shot put channel	17		1
Short throwing markers (set of 10)	18		2
50m plastic sector line (boundary)	18	1	1
Sector line cart	18		1
30m Steel measuring tape	19	1	1
Throwing Equipment Certification unit	18		1
Throwing equipment upon request	17-18	3 of each	3 of each
<b>STADIUM ENVIRONMENT</b>			
Sector flags + fixing pegs	19		100m
Awards' stand	19	1	1
Landing area locking platform	12		2
Electronic count down clock	19		4 to 6
Performance indicator cart	19	5	5 to 7
Chack bowl (+ chalk blocks)	18	2	2
Take-off markers (set of 10)	19	5	6 to 8
Officials' flags white/red (2)	18	6	6
Officials' flags yellow (2)	18	6	6
Officials's clipboard	19	10	20
Equipment cart	12-21	1	1
<b>EQUIPMENT TO BE FIXED DOWN</b>			
Take-off board foundation tray	13	6	6 to 8
Take-off board lid	13	6	6 to 8
Removable vault box	8	1	3



## Competition Info.

- Performance indicator cart: 1 per competition
  - Electronic countdown clock: 1 per competition
  - Wind gauge: 1 per track and competition (long jump & triple jump)
- Equipment desirable but not mandatory.**

## INDOOR CAGE PLAN

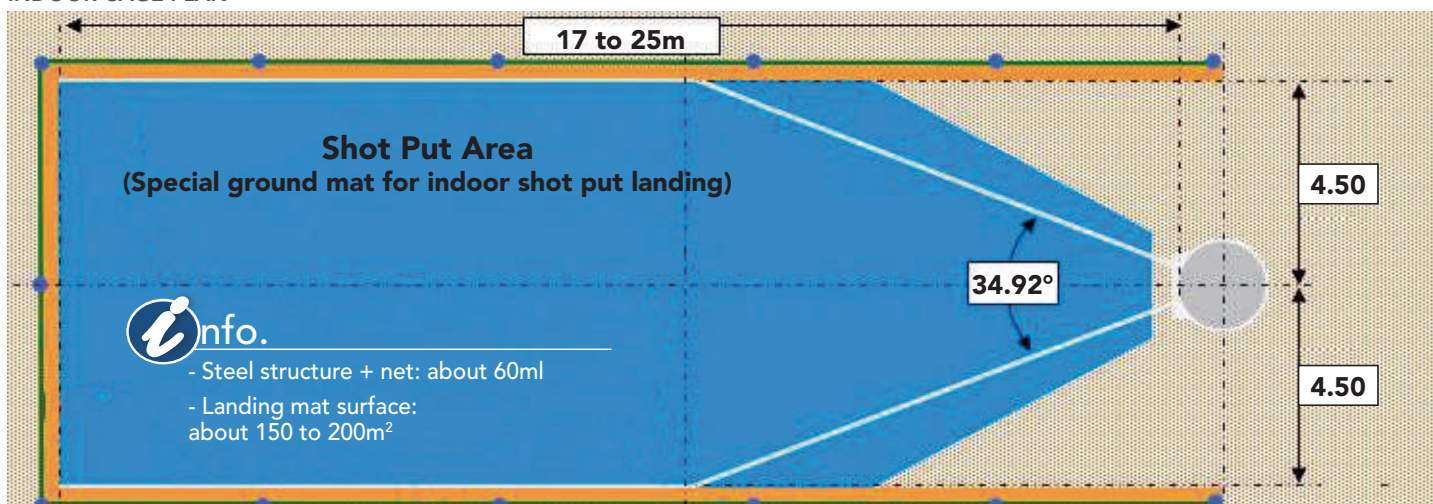

# MADE TO MEASURE

Designer, manufacturer and distributor for more than 50 years, Dimasport puts its experience at your service. Passionate and committed to the sport and athlete world, Dima manufacture in France the custom-made equipment you need.

Thanks to our engineering team, we can assist you and carry out your project.



**YOU HAVE AN IDEA OR HAVE A SPECIFIC NEED,  
DO NOT HESITATE TO CONTACT US!**

☎ 00 33 1 64 40 05 70 @ info@dimasport.fr



Custom made finish protection pad jumping module



Made to measure

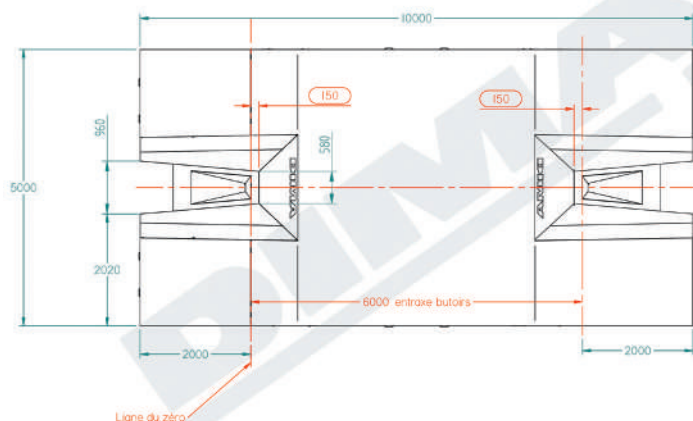

Vault box interaxial adapted double-front landing system



Portable raised running track:  
Raised with the requested inclination

# MADE IN FRANCE

We manufacture our products in our own factories  
in Ozoir-la-Ferriere near Paris.

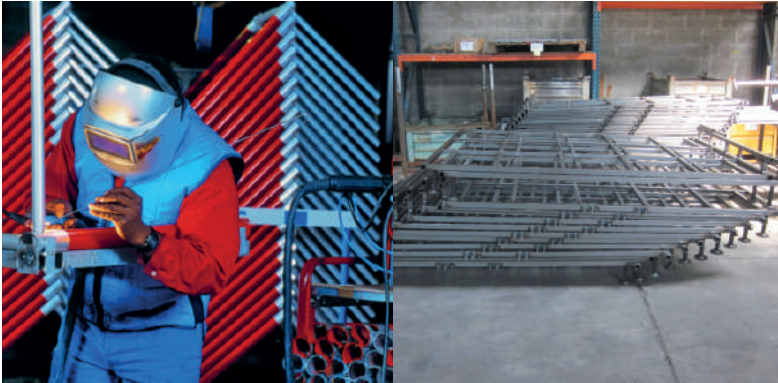

## METALWORK

We cut, drill and weld the steel ourselves.  
Every production stage is rigorously controlled.

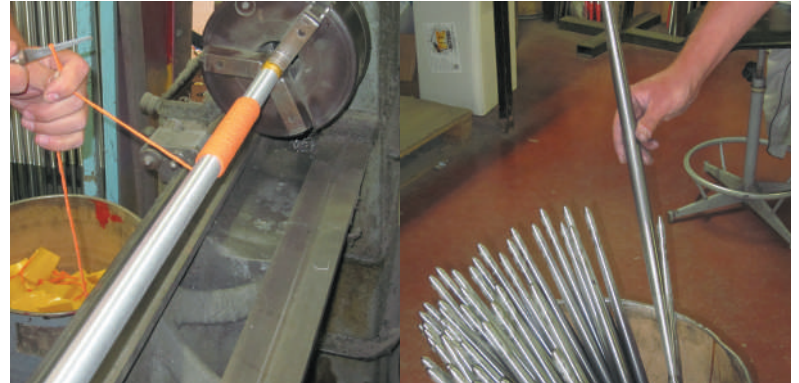

## Atelier Obol

Dima also makes throwing implements: discusses, hammers  
and javelins are manufactured in our factory.

Dima is the only French company to make its own throwing implements.



## TARPAULINS

For over 50 years, we have been constantly improving our processing  
methods to offer top-quality products.

## RAW MATERIALS



Our foams are of the highest  
quality and we know their composition.



Our canvases are inspected and certified.



We select our steels carefully and we know  
where they come from.

We require unremittingly high standards from our suppliers, because the quality of our raw materials largely guarantees the quality of our products. Foam is a costly but fundamental component in our products; we are constantly attentive to its quality and make no compromises.

**MANUFACTURER AND DISTRIBUTOR. DIMA ENSURES FULL INVOLVEMENT**

MADE IN

**DIMASPORT**

FRANCE

# POLE-VAULT REGULATIONS



## F.F.A & I.A.A.F LEVEL 1

- **LANDING SYSTEM:**  
Minimum dimensions of 5.00 x 5.00 x 0.80m (not including front extensions)
- **FRONT EXTENSIONS:**  
Minimum length of 2 m  
Overall dimensions: 7.00 x 5.00 x 0.80m



## I.A.A.F LEVEL 2

(World Championships, Olympic Games)

- **LANDING SYSTEM:**  
Minimum dimensions of 6.00 x 6.00 x 0.80m (not including front extensions)
- **FRONT EXTENSIONS:**  
Minimum length of 2 m  
Overall dimensions: 8.00 x 6.00 x 0.80m



Tested in laboratory conditions, our landing systems conform to **NF EN 12503-2 type 11** standards, as required by federation rules.

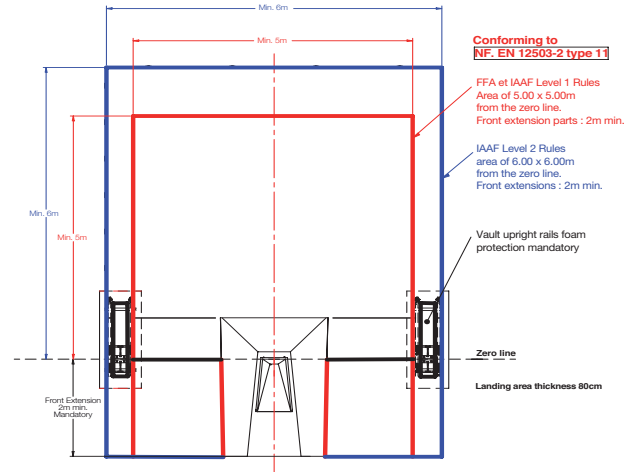

Regulations at all levels (F.F.A & I.A.A.F) require "protection of pole-vault uprights bases using padding made from the appropriate materials"

### See pole-vault standard base pad p. 7

The white "zero line" is shown ON ALL DIMA LANDING SYSTEMS in compliance with F.F.A & I.A.A.F regulations.

## TO HELP YOU CHOOSE!

### 1 Select your type of landing system

3 Various landing system designs are offered to you, for optimum suitability: quality/price/functionality

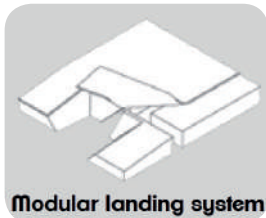

#### 1. MODULAR SYSTEM

Composition: Airfoam units individually encased, lockable, interchangeable and transportable, covered with a 7 or 10cm thick anti-spike top pad, for a uniform, comfortable and flexible landing system.

#### Advantages

- Good level of comfort
- Reversible blocks assembly for longer life
- Allows for easier assembly, moving, and storage (for pole vaulting landing systems, rapid moving of the blocks if the wind changes).



#### 2. COMFORT PLUS SINGLE COVER LANDING SYSTEM

Composition: Airfoam units encased in a single cover, covered with a 7 or 10cm thick anti-spike top pad, for great comfort and flexibility.

#### Advantages

- Very good quality/price balance.

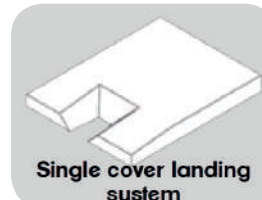

#### 3. SINGLE COVER LANDING SYSTEM

Composition: Airfoam units encased in a single cover, with the top surface made of anti-spike fabric.

#### Advantages

- Price

### 2 Shed options

Shed for security and care (see all sheds on pages 6 to 7).

# HIGH JUMP REGULATIONS



## F.F.A & I.A.A.F LEVEL 1

- **LANDING SYSTEM:**  
Minimum dimensions of 5.00 x 3.00 x 0.70m



## I.A.A.F LEVEL 2

(World Championships, Olympic Games)

- **LANDING SYSTEM:**  
Minimum dimensions of 6.00 x 4.00 x 0.70m



Tested in laboratory conditions, our landing systems conform to **NF EN 12503-2 type 11** standards, as required by federation rules.

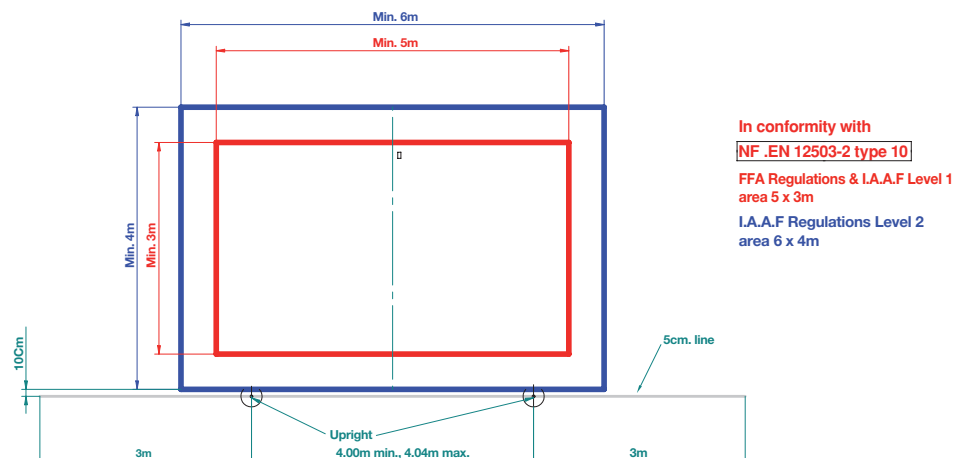

In conformity with **NF .EN 12503-2 type 10**  
FFA Regulations & I.A.A.F Level 1 area 5 x 3m  
I.A.A.F Regulations Level 2 area 6 x 4m

- A**
- ABMAT p. 22
  - Ab wheel p. 22
  - Adjustable GPP foam hurdle p. 5, 20
  - Airfoam replacement units p. 12
  - Aluminium auto return hurdles p. 5, 20
  - Aluminium discus cage p. 16
  - Aluminium height gauge p. 12
  - Aluminium school high jump height p. 12
  - Aluminum drainage dome p. 8, 12
  - Aluminum hammer cage p. 16
  - Ankle p. 22
  - Anti-rebound safety net p. 16
  - Athletics packs p. 24
- B**
- Baby hurdle p. 5, 20
  - Baby trampoline p. 25
  - Bag for hoops p. 21
  - Bag for starting blocks p. 4
  - Balance board/wobble board p. 23, 25
  - Ball toss frame set p. 25
  - Banner fixing post p. 19
  - Bar holder p. 23
  - Base p. 21, 25
  - Basic chalk bowl p. 8, 18
  - Basic squat stand p. 23
  - Beanbag juggling ball p. 25
  - Beginners fiberglass pole p. 25
  - Belt p. 22
  - Bench p. 13, 20, 22, 25
  - Black bumper plates p. 23
  - Blanking lid p. 13
  - Bosu balance trainer p. 23
  - Bracket p. 7
  - Bricks p. 21
  - Bumper plates stacker p. 23
- C**
- Carrying cart for starting blocks p. 4
  - Case of 24 digi DT1 stopwatches p. 4
  - Chalk/magnesia p. 8, 18, 19
  - Classical rig p. 23
  - Climbing rope p. 22
  - Club athletics pack throwing p. 18
  - Comet ball p. 18
  - Comfort wrist/ankle weight p. 22
  - Competition high jump crossbar p. 12
  - Competition pole-vault crossbar p. 8
  - Competition take-off board p. 13
  - Competition telescopic height gauge with pointer p. 8
  - Competition telescopic high jump height p. 12
  - Cone p. 20, 21, 25
  - Cranking handle p. 7
  - Cross-braced hurdles p. 5
  - Crossing ladder p. 23
  - Cross mat p. 20, 25
  - Customized printing p. 12
- D**
- Digi DT 2500 P stopwatch with integrated printer p. 4
  - Dima carrying bag p. 21
  - Dimahop p. 25
  - Dimakid hurdles p. 5, 20
  - Dima official's clipboard p. 8, 19
  - Dips station p. 23
  - Discus p. 17
  - Discus bag p. 17
  - Discus circle p. 16
  - Distance measuring wheel p. 19
  - Dropping mats p. 22
  - Drying surface roller p. 12, 19
  - Dual resistance trainer p. 22
  - Dumbbells p. 23
- E**
- Elastiband p. 22
  - Elastic roll p. 22
  - Elastic roll/bungee cord - 25m p. 8, 12
  - Elastic tape crossbar p. 8, 12
  - Electronic countdown timer p. 19
  - Electronic weighing scale for athletics throwing devices p. 18
  - End-assembling gymnastics track p. 20
  - Equipment cart with towing bracket p. 12
  - Equipment shed p. 15
  - Exercise/Yoga mat p. 20
  - Extra large cylinder foam p. 20
- F**
- Finish posts p. 19
  - Finish protection pad p. 12, 19
  - Fitness cushion pad p. 23
  - Fixed pole rack p. 8
  - Fixing staples p. 18
  - Flag football/rugby belt p. 21
  - Flat cone marker p. 20
  - Foam drainage dome p. 8, 12
  - Foam elastic crossbar p. 8, 12
  - Foam folding hurdle mat p. 5, 20, 25
  - Foam gymnastic beam p. 25
  - Foam hurdle p. 5, 20
  - Foam javelin p. 25
  - Foam Plyo boxes p. 20, 22
  - Foam plyometric box p. 20
  - Foam pole support p. 8, 25
  - Foam protection pad p. 16
  - Foam roller p. 23
  - Foam springboard p. 25
  - Foldable long jump mat p. 24
  - Foldable variable height step hurdles p. 5, 20, 25
  - Foul board cart p. 13
  - Foul board for competition take-off board p. 13
  - Frame for reversible take-off board p. 13
  - Free lane cone markers p. 19
  - Free lane flag p. 19
  - Free-standing high bar p. 22
  - Free-standing parallel bars p. 22
  - Full body workout station p. 23
  - Fully assembling gymnastics school mat p. 20
- G**
- Galvanized platform p. 6, 7, 10, 11, 12
  - GPP hurdles p. 5, 20
  - Grass track line marker p. 19
  - Gymnastic low beam p. 25
  - Gymnastic rings p. 22
  - Gymnastics mat p. 25
  - Gym / swiss ball p. 22
- H**
- Hammer case p. 17
  - Hammer conversion circle p. 16
  - Hammer globe p. 17
  - Hammers p. 17
  - Hammer training replacement handle p. 17
  - Heavy throwing weight p. 17
  - Hemisphere stilts p. 25
  - High jump p. 12
  - High jump landing p. 10, 11
  - High jump standard cart/trolley p. 12
  - High jump standards p. 25
  - Hoops p. 21, 25
  - Hoop wall bracket p. 21
  - HSPU mat p. 22
  - Hurdle carts p. 5
- I**
- Implement certification kit p. 18
  - Individual training mat p. 20
  - Indoor shot put throwing landing system p. 16
  - Installation tray for competition take-off board p. 13
  - Integral pole vault shed p. 14
  - International hurdle p. 5
- J**
- Javelin p. 18
  - Javelin carrying case p. 18
  - Javelin display rack p. 18
  - Javelin/poles carrying tube p. 18
  - J-cups p. 23
  - Juggling ball p. 25
  - Juggling scarves p. 25
  - Jump distance indicator boards p. 13
  - Jump PVC distance indicator board p. 13
- K**
- Kettlebell p. 22
  - Kit p. 21
  - Knocken ball p. 18
- L**
- Ladder p. 20
  - Landing mattress p. 25
  - Lane marker box p. 4, 19
  - Laser distance measuring system p. 19
  - Laser optic measuring device p. 13, 19
  - Long jump p. 13
- M**
- Massage stick p. 23
  - Mat winder with mandrel p. 19
  - Measuring tape p. 19
  - Medicine ball p. 22, 25
  - Medicine ball support belt p. 22
  - Medicine ball with handle p. 17
  - Megaphone p. 4, 19
  - Metric tape p. 18, 25
  - Mini high-jump crossbar placer p. 12
  - Mini hurdle p. 20
  - Mini obstacles p. 5, 20, 25
  - Mini steeplechase barrier p. 5
  - Mobile discus rack p. 17
  - Mobile hammer rack p. 17
  - Mobile pole rack p. 8
  - Mobile shot rack p. 17
  - Mobile storage locker p. 21
  - Mobile storage rack p. 21
  - Mobility course equipment p. 21
  - Multi-activity pack p. 21
- Multicolour plastic bowling p. 25**
- Multi-functional hurdles p. 20**
- Multi-function hurdles p. 21**
- Multi-purpose carrying cart p. 18, 21**
- N**
- Net p. 16
  - Nylon pinnies p. 21
- O**
- Officials' flags red/white p. 8, 18
  - Officials' flags yellow p. 8, 18
  - Olympic bar p. 23
- P**
- Paper roll for printer for DT 2000 stopwatch p. 4
  - Pedometer p. 19
  - Performance indicator cart p. 19
  - Pike-proof top pad p. 12
  - Platform foam module p. 25
  - Plasticine load p. 13
  - Plasticine spatula p. 13
  - Plastic sector line p. 18
  - Plate storage pin p. 23
  - Poles p. 9, 21, 25
  - Pole stacking shed p. 8, 15
  - Pole vault p. 6, 7
  - Pole vault kit p. 8
  - Pole-vault rail base pad p. 7
  - Pole-vault uprights p. 7
  - Pole-vault upright setting indicator board p. 19
  - Portable discus throwing circle p. 16
  - Portable pole rack p. 8
  - Portable raised running track unit width p. 19
  - Portable shot put throwing platform p. 16
  - Post for section banner p. 19
  - Power rack p. 23
  - Power sled p. 4, 22
  - Premium squat cage p. 23
  - Printer for DT 2000 stopwatch p. 4
  - Protection pad p. 7
  - Pull-up bar p. 23
  - Push-up bars p. 22
  - PVC training hurdle adjustable p. 5
- R**
- Rack p. 21, 22
  - Rails p. 7
  - Relay batons p. 4, 19, 25
  - Replacement cover p. 12
  - Resistance cord with handles p. 22
  - Resistance speed chute p. 22
  - Resistance/speed cord p. 22
  - Reversible take-off board p. 13
  - River stones p. 25
  - Rocket javelin p. 18, 25
  - Rolling rack for crossbars p. 8
  - Rolling Rack For Crossbars p. 12
  - Rolling strips p. 16
  - Rostrum p. 4, 19
  - Rotating clips p. 21
  - Round javelin rack p. 18
  - Rubber hammera p. 25
  - Rubber rings p. 17, 25
- S**
- S23571 Seiko stopwatch with integrated printer p. 4
  - Safety spotter arms p. 23
  - Sandbag p. 23
  - Sand border p. 13
  - Sand pit broom p. 13
  - Sand pit cover p. 13
  - Sand pit rake p. 13
  - Sand pit scraper p. 13
  - Sand pit shovel p. 13
  - School hurdle p. 5, 20
  - School mini-hurdle p. 5, 20
  - Section banners p. 19
  - Sector flags p. 18
  - Sector line cart p. 18
  - Seesaw p. 25
  - Set of 10 hands + 10 feet floor markers p. 21
  - Set of game markers p. 21
  - Set of markers p. 21
  - Shed for hurdle carts p. 5
  - Shed on swiveling wheels carts p. 15
  - Shot case p. 17
  - Shot/hammer circle p. 16
  - Shot put p. 17
  - Shot put channel p. 17
  - Shot toeboard p. 16
  - Skipping ropers p. 20
  - Sloping press p. 23
  - Soft bean bags p. 25
  - Spare hammer cable p. 17
  - Special start power sled p. 4
  - Spring collars p. 23
  - Square poly spots p. 25
  - Squat stand p. 23
  - Stacking plinths p. 20
  - Stadium kit p. 24
- Standard high jump shed p. 19**
- Standard pole vault shed p. 15**
- Standard pole vault shed p. 14**
- Stand for gym ball p. 22**
- Start clapper board p. 4, 19**
- Starting block p. 4**
- Steel distance indicator stand p. 13**
- Steeplechase barrier p. 5**
- Steeplechase barrier set transportation cart p. 5**
- Steeplechase water jump barrier p. 5**
- Steeplechase water jump cover p. 5**
- Step foam stairs for long jump p. 24**
- Step hurdle carry strap p. 5**
- Step hurdles p. 5, 20**
- Step ladder - 2 steps p. 12, 19**
- Stopwatch p. 25**
- Stopwatch p. 4**
- Storage rack for dumbbells p. 23**
- Straight line floor markers p. 25**
- Summer skis for children p. 25**
- Support for foldable pole-vault standards p. 7**
- Surround protection structure p. 16**
- Swivelling wheels for pole stacking shed p. 8, 15**
- T**
- Tactile discs mobility course p. 25
  - Take-off board markers p. 13
  - Take-off markers p. 8, 19
  - Take-off mat p. 24
  - Tape skate kit p. 13
  - Target p. 18, 25
  - Target hoops p. 18
  - Throwing area p. 18
  - Throwing distance field markers p. 18
  - Throwing distance marker box p. 18
  - Throwing ring p. 17, 25
  - Timing platform with camera stand p. 19
  - Training hurdles p. 5
  - Training markers p. 25
  - Training synthetic track roll p. 19, 20
  - TRX p. 22
  - Tug of war rope p. 25
  - Turbo javelin p. 18
- V**
- Vault box p. 8
  - Vault box lid p. 8
  - Vehicle towing bracket for hurdle cart p. 5
  - Vertical plate tree p. 23
  - Vertical transportation cart p. 12
  - Vinyl tape p. 21
- W**
- Wall ball p. 22
  - Wall ball target p. 23
  - wall bars p. 22
  - Weather cover p. 6, 7, 10, 11, 12
  - Weather cover for 8 hurdle p. 5
  - Weighted ball p. 17
  - Weighted glove p. 22
  - Weighted vest p. 22
  - Whistle p. 19
  - Wind gauge p. 19
  - Windsock p. 8, 19
  - Wind speed indicator cart p. 19
  - Wireless sprint timing system p. 4
  - Wooden adaptor for competition take-off board p. 13
  - Wooden beam p. 5
  - Wooden gymnastic vaulting box p. 22
- Y**
- Yoke p. 23

# DIMASPORT

## Sports Equipment

1 bis, rue Louis Armand - B.P 91- 77834 OZOIR-LA-FERRIERE CEDEX France

Tél : +33 1 64 40 05 70 – Fax : +33 1 64 40 00 37

www.dimasport.fr – info@dimasport.fr

### Customized Dima Bags on request



Customized Dima Bags  
Create your own logo, send it to us with your order  
and we will silk-print it

Ref.10832	Large blue customized bag
Ref.10833	Large red customized bag
Ref.10834	Small blue customized bag
Ref.10791	Small red customized bag

MINIMUM ORDER 30

 Find all our bags on our website  
[dimasport.fr](http://dimasport.fr)









#### Classic Dima

Ref.10801	Large blue bag
Ref.10802	Large red bag
Ref.10790	Small blue bag
Ref.10789	Small red bag

**DIMA**

Montrer 12 par page Tri

Résultats 1 - 18 sur 18.

<p><b>DIMA BLUE-WHITE-RED BAG</b></p>  <p>à partir de 30,00 €</p>	<p><b>DIMA COMBINED EVENTS BAG</b></p>  <p>à partir de 35,00 €</p>	<p><b>DIMA TRACK SPIKES BAG</b></p>  <p>à partir de 15,00 €</p>
<p><b>DARKSIDE DIMA BAG</b></p>  <p>à partir de 25,00 €</p>	<p><b>DARKSIDE DIMA BAG</b></p>  <p>à partir de 59,00 €</p>	<p><b>DIMA GYMNASTICS BAG</b></p>  <p>à partir de 25,00 €</p>

